

NOVEMBER/DECEMBER 2009

BUYER'S GUIDE 2009-2010

COMPANY PROFILES

Hayward Baker, Inc.
ESAB Welding & Cutting
enXco Service Corp.

Q&A: Ron Asche

Nebraska Public Power District

WIND
S Y S T E M S



Our wind tower solutions will blow you away.

WELDING + CUTTING + AUTOMATION = WIND TOWER SOLUTIONS



Subarc Wire and Flux



Mechanized Cutting



Welding Automation

What's the most efficient way to produce your wind tower? Turn to ESAB for a complete manufacturing solution. We have everything you need, all in one place – from mechanized cutting machines to automated welding systems to the broadest selection of filler metals and fluxes. Our experts will provide a turnkey solution, from factory layout to unequalled support that will keep your operation running at maximum efficiency. So let ESAB power the fabrication of your wind tower.

esabna.com + 1.800.ESAB.123



ESAB Welding & Cutting Products

Welcome to the New G&E

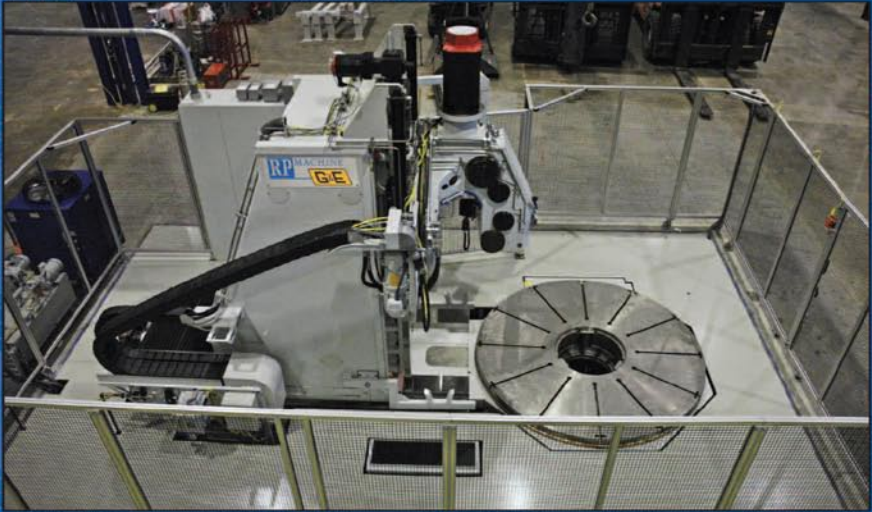

G&E's NEW Product Lines include:

- > CNC Hobbing Machines
- > CNC Gashing Machines
- > Combination Hobbing/Gashing Machines with interchangeable heads for external & internal gears
- > Custom gear related equipment
- > CNC Retrofit and Rebuilding of existing G&E equipment

G&E has been a pioneer in high-speed gear gashing with large diameter carbide inserted cutters. We offer heavy duty gashing heads for internal and external applications. Our new machines have a rugged design and our heads utilize today's state of the art gashing cutter technology. We continue to work with the top cutter manufacturers to optimize the results of our machines.

An OEM for Large Capacity Gear Gasher/Hobbers for Wind Energy, Mining, Off-Highway, and Construction

**Largest Builder of Wind Energy Gashers
in North America and Maybe the World???**

RP MACHINE
ENTERPRISES, INC

www.rpmachine.com • sales@rpmachine.com
T: 704-872-8888 • F: 704-872-5777

Visit us at booth #8401 at Windpower 2010, Dallas, Texas
May 24th - 26th

GLEASON TOTAL SOLUTIONS FOR

BIG GEARS



Large Gears, Big Performance: Only from Gleason.

The world's industries are hungry for new and better ways to produce large gears faster and more economically. Gleason's ability to meet this growing need is unmatched. No other company has the technology to deliver such significant improvements in workpiece cost and quality for the full range of cutting, grinding and inspection operations – on the very largest gear sizes.



Download our
Big Gears brochure at
www.gleason.com/largegears.

eNews

Register today for monthly eNews, visit...

Gleason

www.gleason.com • sales@gleason.com

KEEPING THE WORLD IN MOTION™

BUYER'S GUIDE



8 CONSTRUCTION

Topics include Concrete, Connectors/Tooling/Grounding Equipment, Control Devices, Cranes, Data Loggers, Electrical Services, Encoders, Fasteners, Foundations, Heavy Equipment, Met Towers, Ocean Shipping, Ports/Terminals, Power Conditioning/Storage, Project Due Diligence, Substations, Switches, Third-Party Logistics, Tool/Equipment Leasing, Tools/Tensioning, Trucking Services, Transformers, Wire/Cable.



36 MAINTENANCE

Information on Alignment Equipment, Blade Services, Condition Monitoring Equipment, Condition Monitoring/Analysis, Gearbox Repair, Generator Repair, Inspection Equipment, In-Tower Lifts, Lighting, Lightning/Surge Protection, Lubricants/Filters/Filtration Systems, Operations.

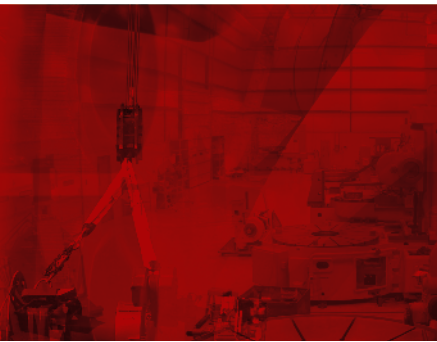

46 MANUFACTURING

Blades, Braking, Coatings/Chemicals, Composites, Contract Machining, Cutting Tools, Design Services/Equipment, Drivetrains, Electrical, Gears/Bearings, Gear Manufacturing Equipment, Generators, Hubs/Rings/Forged Components, Machining Centers/Machine Tools, Metal Fabrication, Metrology, Turbines/Components, Steels/Metals, and more.



66 MISCELLANEOUS

Asset Management/Financial Software, Associations, Certification/Testing, Consulting, Economic Development, Environmental Services, Finance, Insurance, Land/Permitting, Landowner/Project Evaluation, Legal Resources, Safety Training, Staffing/Recruiting, Training, Wind Resource Analysis, etc.

12

CONSTRUCTION

HAYWARD BAKER, INC.

An international expert on geotechnical construction techniques, these are the professionals to contact to ensure that your foundation systems are safe, reliable, and cost effective. James D. Hussin, a company director, discusses Hayward Baker's emergence as the premier specialty geotechnical foundation company with capabilities including foundation support, settlement control, and seismic stabilization, among others.

42

MAINTENANCE

enXco SERVICE CORP.

In the early 1900s this company revolutionized the welding process, leading to stronger ships, steel structures, and many years later, wind towers. Richard Hadley—president of ESAB Group Canada, Inc., and general manager of ESAB Welding Automation North America—describes the many roles the company plays within the wind industry, supporting innovation and efficiency.

60

MANUFACTURING

ESAB WELDING & CUTTING

Even as it keeps an eye on its customer's assets, this company conducts quality-control assessments of its own operations, providing additional confidence in its abilities. David Luck, director of business development, discusses the early days of the North American wind industry and outlines the company's services, including maintenance, parts procurement and inventory control, remote monitoring, and comprehensive reporting.

80

Q&A

RON ASCHE, PRESIDENT & CEO

Nebraska Public Power District

RESOURCES

MARKETPLACE 77

ADVERTISERINDEX 79



Wind Systems magazine, published by Media Solutions, Inc., is printed entirely on Forest Stewardship Council certified Domtar Lynx paper. FSC certification ensures that this paper contains fiber from well-managed and responsibly harvested forests. The FSC logo also signals our commitment to improving the environment. *Wind Systems* paper is also Rainforest Alliance certified. Publications mail agreement no. 40624074 Return undeliverable Canadian addresses to: PO Box 503 | RPO West Beaver Creek | Richmond Hill, ON L4B 4R6

Equipment That Won't Let You Down.

Keep Your Crews Working. Not Waiting.

To get maximum productivity on the job, trust RSC Equipment Rental. Our top-quality equipment is maintained to high standards, so you can depend on it.

Give us your biggest challenge and we'll give you a solution. Call 800.394.9400 or visit RSCdelivers.com/WS anytime, 24/7 for the most reliable equipment.

800.394.9400



Schedule
Contract GS-21F-0036T

RSC Equipment Rental is proud to provide equipment from quality manufacturers such as:

Genie
A TEREX BRAND

RSCdelivers.com • **800.394.9400**

2007-2009 © RSC Equipment Rental, Inc. All Rights Reserved.

EDLETTER

As you review our first annual buyer's guide you'll notice that it's more streamlined than what you may be accustomed to. While working to compile what we hope will prove to be a collection of information that you'll find extremely useful, we considered how the delivery of information has changed over the years. Although physical addresses may once have been a critical component of such a listing, we feel that the Internet and an increasingly global business community have changed that necessity. While you may find it interesting to know where a supplier is headquartered, chances are their location wouldn't deter you from doing business with them. So we decided to jettison all of that and focus on clear categories, the company's name and phone number, and their Web address, where every conceivable piece of information you're looking for should be available. I'd also like to point out that this listing is a work in progress, and although we've done our best to make it as complete as possible, we need to hear from anyone who doesn't appear and would like to be included in next year's listing. Even as it stands, however, you will not find a more comprehensive list of wind-energy resources.

Even though this issue is mostly comprised of contact information, we wanted to provide you with something to read as well, so we're honored to present profiles of three companies that are major players in the wind industry. enXco Service Corp. has been involved since wind energy first began to surface in the United States, providing O&M services before there really was such a thing. Hayward Baker can make the same claim, although it was established much earlier as a small utility construction company before becoming one of the world's leading specialty geotechnical foundation companies. You will also learn of how ESAB Welding & Cutting came into being, revolutionizing welding technology in the process. I'd like to thank Dave Luck of enXco Service Corp., Jim Hussin of Hayward Baker, and Richard Hadley of ESAB for taking the time to share their company's stories with me... but that's not all. As a special parting gift we're pleased to feature Ron Asche, president and CEO of the Nebraska Public Power District (NPPD) as this issue's Q&A subject. It was a pleasure speaking with all of these gentlemen, and you're sure to enjoy learning about their activities and capabilities.

As I've mentioned before, thanks to your support of *Wind Systems* magazine we will begin monthly production in January 2010, so there will be plenty of publishing opportunities for those of you who are interested in contributing editorial content. Please feel free to contact me at the e-mail address listed below if you have a story idea or an article to submit, and I'd like to extend all of our appreciation for having the opportunity to work with you in the coming year!



Russ Willcutt, editor
Wind Systems magazine
russ@windssystemsmag.com
(800) 366-2185



David C. Cooper
Publisher

Chad Morrison
Associate Publisher

EDITORIAL
Russ Willcutt
Editor

Kassie Hughey
Assistant

SALES
Brad Whisenant
National Sales Manager

Glenn Raglin
Regional Sales Manager

Tom McNulty
Regional Sales Manager

CIRCULATION
Teresa Hall
Manager

Jamie Willett
Assistant

Kassie Hughey
Assistant

ART
Jeremy Hallen
Art Director
Michele Hall
Graphic Designer

 **media solutions**

PUBLISHED BY MEDIA SOLUTIONS, INC.
P. O. BOX 1987 • PELHAM, AL 35124
(800) 366-2185 • (800) 380-1580 FAX

David C. Cooper
President

Chad Morrison
Vice President

Teresa Hall
Operations

No part of this publication may be reproduced or transmitted in any form or by any means, electronic or mechanical, including photocopying, recording, or any information storage-and-retrieval system without permission in writing from the publisher. The views expressed by those not on the staff of *Wind Systems* magazine, or who are not specifically employed by Media Solutions, Inc., are purely their own. All "News" material has either been submitted by the subject company or pulled directly from their corporate web site, which is assumed to be cleared for release. Comments and submissions are welcome, and can be submitted to russ@windssystemsmag.com.



Thanks, Dad!



*Not everyone can
provide parts directly and quickly.
We can! SSB.*

Slow response on parts orders got you down?
We're here to get you up and running.
SSB Service Inc. is now offering spare parts directly from its U.S. location.
How can we serve you?

Talk to us: 515.986.9101
www.ssb-group.com | SSB. Experience works.





CONSTRUCTION

Concrete	9	Ports/Terminals.....	24
Connectors/Tooling/Grounding Equipment.....	9	Power Conditioning Equipment.....	25
Construction Services.....	9	Power Metering/Relaying Equipment.....	25
Control Devices.....	11	Power Storage.....	25
Cranes	11	Project Due Diligence	26
Data Loggers	14	Railroads	26
Electrical Services.....	14	Substations	26
Enclosures	16	Switches/Switchgear.....	28
Encoders	16	Third-Party Logistics	28
Engineering Services.....	17	Tool/Equipment Leasing	30
Fasteners	19	Tools/Tensioning.....	30
Foundations/Components.....	20	Trucking Services.....	30
Foundations/Systems.....	20	Transformers.....	32
Foundations/Services.....	21	Transmission Towers.....	32
Heavy Equipment	21	Windfarm Design/Mapping.....	32
Meteorological Towers.....	22	Wind Resource Forecasting/Assessment.....	33
Meteorological Towers/Installation.....	22	Wind Sensing Equipment.....	34
Networking	24	Wire/Cable	34
Ocean Shipping Services.....	24		

CONCRETE

Ambassador/NuFab Steel
(612) 788-2928
www.ambsteel.com

Brundage Bone Concrete Pumping
(253) 854-3333
www.brundagebone.com

Concast
(507) 732-4095
www.concastinc.com

Concrete Mobility
(325) 728-5858
www.concretemobility.com

Densit ApS
45 9167011
www.densit.com

Highland Concrete Co., Inc.
(432) 563-8036
www.highland-concrete.com

RSC Equipment Rental
(800) 222-7777
www.rscrental.com

Suncoast Post Tension, Ltd.
(703) 492-4949
www.suncoast-pt.com

White Construction, Inc.
(765) 828-2572
www.whiteconstruction.com

**CONNECTORS/TOOLING/
GROUNDING EQUIPMENT**

3M Electrical
(800) 245-3573
www.3m.com

Bal Seal Engineering, Inc.
(800) 366-1006
www.balseal.com

Cicame Energie
(450) 679-7778
www.cicame.ca

CommScope
(828) 323-4936
www.commscope.com

Galvan Industries, Inc.
(704) 455-5102
www.galvanelectrical.com

Lapp Insulator LLC
(585) 768-6221
www.lappinsulator.com

Maclean Power Systems
(450) 698-0520
www.macleanpower.com

Marsh Electronics, Inc.
(800) 236-8327
www.marshelectronics.com

Penn-Union Corp.
(814) 734-1631
www.penn-union.com

Storm Copper Components Co.
(423) 334-7223
www.stormcopper.com

Thomas & Betts
(800) 888-0211
www.tnb.com

CONSTRUCTION SERVICES

Aadland Evans Constructors, Inc.
(503) 241-0050
www.aadlandevans.com

Acterra Group, Inc.
(800) 289-7371
www.acterragroup.com

Agri System
(406) 245-6231
www.agrisystems.net

Aristeo Construction
(734) 427-9111
www.aristeo.com

Associated Contractors, Inc.
(325) 672-7806
www.assoccontractors.com

Barnard Construction Co., Inc.
(406) 586-1995
www.barnard-inc.com

Barton Malow Company
(824) 584-6300
www.bartonmalow.com

Beta Engineering LLC
(318) 487-9599
www.betaengineering.com

Béton Provincial, Ltd.
(418) 562-0074
www.betonprovincial.com

Blattner Energy, Inc.
(320) 356-7351
www.blattnerenergy.com

BlueScope Construction, Inc.
(816) 245-6000
www.bucon.com

Borton LC
(620) 669-8211
www.borton.biz

Butler Manufacturing Co.
(800) 492-4926
www.butlermfg.com

Carstensen Contracting
(507) 825-2026
www.carstensencontracting.com

Capps Van & Truck Rental
(800) 900-0532
www.cappsvanrental.com

Clyde Industrial LLC
(440) 653-1062
www.clydeindustrial.com

CMW Builders LLC
(409) 838-1114

Crestline Construction Co.
(541) 506-4000
www.crestlineconstruction.com

Dacon/Dashiell
(281) 479-7409
www.dashiell.com

Delaney Group, Inc.
(518) 661-5304
www.thedelaneygrp.com

Densit ApS
45 9167011
www.densit.com

Doherty Welding LLC
(541) 443-3234
www.dohertywelding.com

Dolan Directional Drilling, Inc.
(817) 482-1680
www.dolandirectional.com

Dynamic Industries, Ltd.
(250) 426-3713
www.dynamicindustries.ca

Encore Power Services
(281) 312-0123
www.encorepowerservices.com

Fagen, Inc.
(320) 564-3324
www.fageninc.com

GlenMartin, Inc.
(800) 486-1223
www.glenmartin.com

Graham Construction
(403) 253-1314
www.graham.ca

Graycor Construction
(708) 206-3681
www.graycor.com

Hayward Baker, Inc.
(410) 551-8200
www.haywardbaker.com

Henkels & McCoy, Inc.
(888) 436-5357
www.henkels.com

Henry Carlson Co.
(605) 336-2410
www.henrycarlson.com

Hubbell Power Systems
(573) 682-5521
www.hubbellpowersystems.com

IMPACT
(202) 393-1147
www.impact-net.org

Industrial Maintenance Services, Inc.
(218) 744-4230
www.imscontracting.com

Invenergy
(312) 506-1474
www.inveneryllc.com

Iron Workers Local #86
(206) 248-4246
www.local86.org

Kenny Construction Co.
(847) 541-8200
www.kennyconstruction.com

Kentak Products Co.
(330) 382-2000
www.kentak.com

Kiewit Power, Inc.
(360) 693-1478
www.kiewit.com

Kiewit Texas Construction
(817) 337-7000
www.kiewit.com

K-Line Maintenance & Construction, Ltd.
(905) 640-2002
www.k-line.ca

L. Nardella Associates, Ltd.
(450) 967-1000
www.nardellagroup.com

Lancaster Trenching, Inc.
(208) 326-5929
www.lancastertrenching.com

Marco
(563) 324-2519
www.marcousa.com

Michels Corp.
(920) 583-3132
www.michels.us

Mirka Abrasives
(234) 380-3148
www.mirka.com

ModSpace
(610) 232-0917
www.modspace.com

Morgan & Son Earthmoving, Inc.
(509) 925-9720
www.morganearthmoving.com

Mortenson Construction
(763) 287-5489
www.mortenson.com

Oftedal Construction, Inc.
(307) 237-4499
www.oftedalconstruction.com

P.S.D., Inc.
(330) 452-4434
www.psdohio.com

PAR Electrical Contractors
(816) 474-9340
www.parelectric.com

Pike Electric, Inc.
(512) 369-1670
www.pike.com

Pipeline Skid Service
(830) 792-5445
www.pipelineskidservice.com

Power Partners MasTec LLC
(704) 329-8277
www.powerpartnersllc.com

Preneal Canada, Inc.
(506) 389-9801
www.preneal.ca

BRONTO SKYLIFT®

Work Safer

Nothing beats a Bronto aerial for safety when inspecting, cleaning and servicing wind turbines. And, they do it faster and more productively, so you save time and money!

They're available in a wide range of sizes and offer optional features like integrated washers and generators to meet your specific needs.

Working heights to 330 feet!

Above all

A subsidiary of Federal Signal Corporation

Model S150 XDT
150' Working Height

Model S200 XDT
200' Working Height

Model S230 XDT
230' Working Height

Model S295 HLA
295' Working Height

Model S330 HLA
330' Working Height

For more information, call or visit us on the web
352/895-1109 • www.bronto.fi

Proctor's Transport, Inc.
(541) 454-2833
www.proctorstransport.com

Quanta Services
(713) 629-7600
www.quantaservices.com

Quin Wind, Inc.
(605) 271-7383
www.qwindinc.com

Radco Communications
(775) 781-2268
www.radcocommunicationsllc.com

RES Americas, Inc.
(303) 439-4200
www.res-americas.com

Rhino Marking Systems, Inc.
(866) 622-4343
www.rhinomarkers.com

Rigarus Construction, Inc.
(519) 669-5040
www.rigarus.com

RMT, Inc.
(608) 662-5222
www.rmtinc.com

Robert B. Somerville Co., Ltd.
(905) 833-3100
www.rbsomerville.com

Roncelli, Inc.
(586) 264-2060
www.roncelli-inc.com

Run Energy
(325) 795-1550
www.runenergy.com

RWF BRON
(519) 421-0036
www.bronrwf.com

SDT, Inc.
(601) 823-9440
www.sdt-1.com

Signal Wind Energy LLC
(423) 443-4190
www.signalwind.com

Smalley Heating and Cooling
(785) 246-2327
www.smalleenergy.com

Southbrook Consulting Group, Inc.
(403) 461-3072
www.scginc.ca

Team Fishel
(614) 274-8100
www.teamfishel.com

Tetra Tech
(626) 351-4664
www.tetrattech.com

TexasTremors.com
(940) 855-1853
www.texas-tremors.com

The Axiom Group
(316) 425-0232
www.tagincaxiom.com

The Boldt Co.
(920) 739-6321
www.theboldtcompany.com

Tiltran Services, Inc.
(519) 842-6458
www.tiltran.com

Tower Systems, Inc.
(605) 886-0930
www.towersystems.com

TVIG, Inc.
(609) 678-8344
www.tvigroup.com

Unisorb-Grout
(888) 486-4767
www.unisorb.com

US Energia LLC
(248) 589-9070
www.usenergia.com

W.R. Casteel Co., Inc.
(724) 437-3672
www.wrcasteel.com

Walbridge
(412) 241-8524
www.walbridge.com

**Wanzek Construction-
a MasTec Company**
(701) 282-6171
www.wanzek.com

WennSoft
(262) 821-4100
www.wennsoft.com

White Construction, Inc.
(765) 828-2572
www.whiteconstruction.com

Wind Developers LLC
(214) 450-6168
www.winddevelopersllc.com

**Wind Energy
Services Co.**
(877) 349-2423
www.usawindenergyservices.com

**WindPower
Structures**
(866) 940-8368
www.windpowerstructures.com

Zachry Construction Corp.
(210) 871-2700
www.zachrycorp.com

CONTROL DEVICES

Aluminum Alloys
(610) 678-8023
www.aluminumalloysinc.com

Apterra Technologies LLC
(978) 430-9069
www.apterratech.com

AZZ, Inc.
(817) 810-0095
www.azz.com

Bachmann Electronic Corp.
(847) 249-3003
www.bachmann.info

Baldor Electric Company
(479) 646-4711
www.baldor.com

**Emerson Power & Water
Solutions**
(412) 963-4000
www2.emersonprocess.com

Emerson Process Management
(425) 391-0847
www.emersonprocess-powerwater.com

Ingeteam
(262) 240-9850
www.ingeteam.com

Metal Systems, Inc.
(423) 894-9268
www.equipmentcenters.com

Midori America Corporation
(714) 449-0997
www.midoriaamerica.com

Rittal Corp.
(800) 477-4000
www.rittal-corp.com

Spirae
(970) 484-8259
www.spirae.com

Staco Energy Products Co.
(937) 253-1191
www.stacoenergy.com

Tier Electronics
(262) 251-6900
www.tierelectronics.com

CRANES

A.W. Leil Cranes and Equipment
(902) 449-5238
www.awleil.com

Abet Crane & Rigging Corp.
(800) 724-3366
www.abetcrane.com

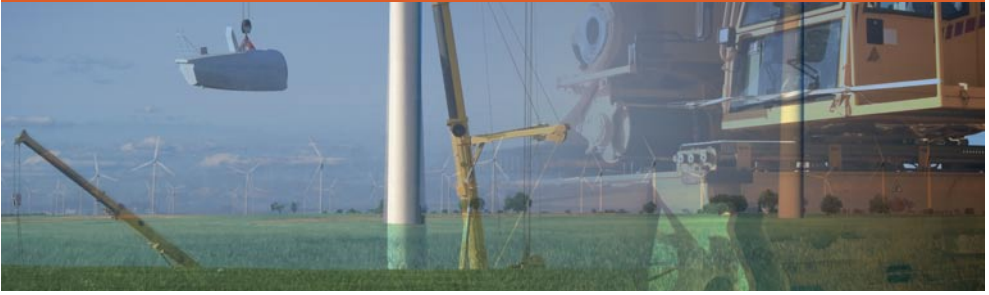

An international expert on geotechnical construction techniques, contact these professionals to ensure that your foundation systems are safe, reliable, and cost effective.

JUST AS A CONFIDENT PERSON IS SAID to have deep inner resources, Hayward Baker—a premier global geotechnical construction firm—can claim the same, with thousands of experienced professionals linked together by the company’s intranet, providing a platform for sharing perspectives to the benefit of its many clients.

“It really is an amazing resource,” according to James D. Hussin, a company director. “I can send out a query concerning a project we’re working on here in the States, and within minutes I’ll receive input from my colleagues around the world who have experienced similar challenges. That’s just one of the benefits we enjoy as a member of the Keller Group.”

Launched in 1946 as a small utility construction company in California by the company’s namesake, it was his son, Wallace Hayward Baker, who led its growth to international prominence. “After earning his doctorate in geotechnical engineering from Northwestern University, he went to work for an engineering company in Spain that introduced him to ground treatment,” Hussin explains. “He then brought what he’d learned back to the company his father had founded, branching out into the tunneling industry and working on projects such as the metro tunnels in Washington, D.C. He was really the one responsible for establishing our identity as the premier specialty geotechnical foundation company.”

Among the services it offers are foundation support and rehabilitation, settlement control, structural support, site improvement, soil and slope stabilization, underpinning, excavation shoring, earth retention, seismic stabilization, and ground water control.

By the time the wind industry began to surface in the United States, Hayward Baker was so widely acknowledged as the expert in foundation systems that its entry into the market was basically an organic process. “Geotechnical engineers working on wind projects began contacting us to provide input on the

reports they were preparing, and we’ve always been more than willing to share our knowledge and expertise,” Hussin says. “So we’d consider load factors and soil conditions and help them arrive at the most efficient and economical solution, which is our goal in working with our wind customers to this day.”

Quite often those customers are wind-farm owners, or the engineers they’ve hired, who are seeking approaches to foundation design that will bolster the project’s economic feasibility. “Building a safe and reliable foundation economically is very important to the owners,” he says, “and they need to be certain it’s going to perform properly before proceeding with development of the project. The years of experience we bring to the table, along with our work on wind projects around the world, allows them to do so with confidence.”

Having spent some 25 years with the company, beginning as a design engineer and eventually working his way up to chief engineer, Hussin now operates at the corporate level, meeting with wind-farm owners, engineers, and contractors throughout North America to answer questions, ascertain their needs, and make sure they are being met. “Having been involved with every aspect of our business, I understand our services extremely well and share that knowledge with our customers, especially on projects that are a little more challenging or out of the ordinary,” he says. “We see the U.S. wind industry as a very large growth market, and we’re in a position to support that growth by offering our creative, problem-solving skills and foundation construction resources to wind-industry professionals.”

With its roots in the American construction industry, bolstered by its affiliation with the international Keller Group, Hayward Baker steers its clients toward success in a singular way. “Our culture of sharing information internally makes for a very synergistic group,” Hussin says, “and it results in major benefits for our customers.” — *Russ Willcutt* ↗

To learn more go to www.haywardbaker.com.

CONSTRUCTION

Actek Manufacturing & Engineering
(626) 581-3424
www.actekmfg.com

Big Iron Crane Service LLC
(580) 920-2244
www.bigironcrane.com

Bigge Crane and Rigging Co.
(510) 638-8100
www.bigge.com

Bragg Crane
(562) 984-2400
www.braggcrane.com

Crane Rental Corp.
(407) 277-5000
www.cranerental.com

Crane Service, Inc.
(800) 233-2763
www.craneserviceinc.com

CR Holland Crane Service, Inc.
(641) 585-3630
www.crhollandcrane.com

Essex Crane Rental Corp.
(847) 215-6500
www.essexcrane.com

Hinkel Equipment Rental
(215) 673-6700
www.hinkrent.com

Imperial Crane Services, Inc.
(708) 598-3700
www.imperialcrane.com

Irving Equipment
(506) 635-5555
www.irvingequipment.com

J.J. Curran Crane Co.
(313) 842-1700
www.jjcurran.com

JPW Riggers
(800) 724-0937
www.jpwriggers.com

Kobelco Cranes North America
(713) 856-5755
www.kobelcocranesnorthamerica.com

Lampson International
(509) 586-0411
www.lampsoncrane.com

Liebherr
(713) 636-4085
www.liebherr.com

Lomma Crane & Rigging
(412) 445-4000
www.jflommainc.com

Mains Crane & Rigging, Ltd.
(780) 955-1782
www.mainscrane.com

IDEAL for Windmill Projects

easily attaches to any skid steer



The SP42 hydraulic vibratory compaction unit comes with a 42-inch diameter wheel and is designed for trenches up to 24 inches in width and 34 inches deep. Its capability for pivoting 7 degrees in either direction makes it ideal for slopes.

99 Hwy 64W
Fair Oaks, AR 72101
888-697-2225
trenchgrader.com

TRENCH GRADER

Mr. Crane

Lifting and Rigging Solutions 714.633.2100



5 Ton - 500 Ton Cranes
Lift Engineering
Turnkey Installation
40 Years Experience

www.MrCrane.com

Manitowoc Company
(920) 684-4410
www.manitowoc.com

Mr. Crane
(800) MRCRANE
www.mrcrane.com

Northwest Crane Service LLC
(405) 373-2979
www.northwestcraneservice.com

Phillippi Equipment Co.
(651) 406-4900
www.pecoequip.com

RSC Equipment Rental
(800) 222-7777
www.rscrental.com

Stevenson Crane Service
(630) 972-9199
www.stevensoncrane.com

Truck Crane Service
(651) 406-4949
www.truckcraneservice.com

Turner Bros. LLC
(800) 666-1723
www.turnerbros.com

Walter Payton Power Equipment
(800) 922-5508
www.wppellc.com

**Wanzek Construction-
a MasTec Company**
(701) 282-6171
www.wanzek.com

White Construction, Inc.
(765) 828-2572
www.whiteconstruction.com

DATA LOGGERS

AEMC Instruments
(508) 698-2115
www.aemc.com

Anemometry Specialists, Inc.
(712) 200-2281
www.anemometry.com

APRS World LLC
(507) 454-2727
www.aprsworld.com

Campbell Scientific, Inc.
(435) 753-2342
www.campbellsci.com

CCS-Inc.
(800) 277-3077
www.ccs-inc.com

Onset Computer Corp.
(800) 564-4377
www.onsetcomp.com

RainWise, Inc.
(800) 762-5723
www.rainwise.com

SecondWind, Inc
(617) 776-8520
www.secondwind.com

Tempco Electric Heaters
(888) 268-6396
www.tempco.com

ELECTRICAL SERVICES

Aevenia
(218) 284-9522
www.aevenia.com

Aldridge Electric
(847) 236-0098
www.aldridge-electric.com

ROHN™
Products

**From 1kW —
— up to 100kW**
Wind Turbine Tower Designs

ROHN is supporting the global search for alternative energy sources with turbine support structures and meteorological towers around the world.

ROHN Products has extensive experience in manufacturing turbine support structures in support of wind energy applications. Whatever the requirement, Tapered Steel Poles, Self-Supporting Towers or Meteorological Towers, ROHN has the answer.

- Engineered Designs
- Fabrication Meets TIA/EIA and CSA
- Foundation Installation
- Civil Construction
- Tower Accessories
- Optional Items Also Available (Climbing Ladders, Safety Climbing Devices and EIA Grounding)

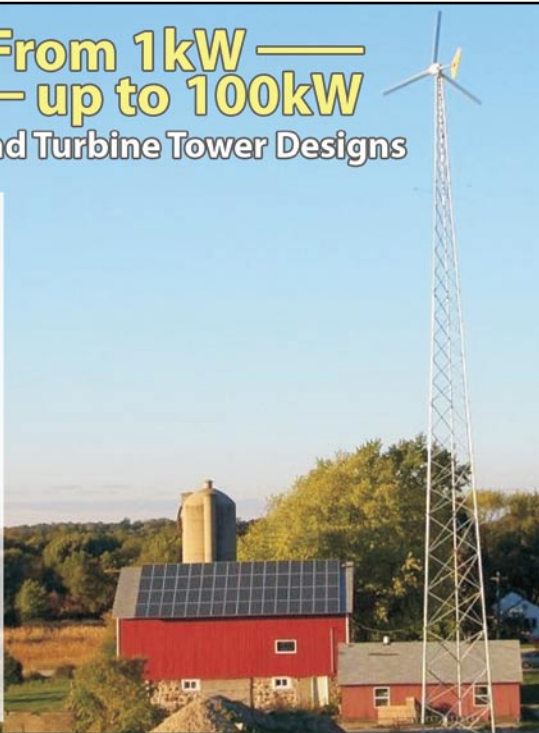

6718 W. Plank Road • Peoria, IL 61604 • (800) 727-ROHN • www.rohnet.com

HAVLIK GEAR

WE'VE EXPANDED WITH A NEW LOCATION.
OUR NEW GEAR GRINDING AND MANUFACTURING FACILITY
HOUSES ONE OF THE LARGEST GRINDERS IN NORTH AMERICA.



KAPP O NILES

The ZP 40 grinding machine features the ultimate in design construction with true hydrostatic guideways and rotary table. The work table is direct drive. Nodular cast iron is used for the machine beds, columns, and all sub-assembly housings, for stability. The machine accuracy is therefore assured for a long lifetime.

The ZP40 is designed to profile grind spur and helical external and internal gears using dressable corundum or sintered grinding wheels. An integrated measuring device further increases machine's flexibility. The ZP machine can be set up to accommodate application-specific requirements for maximum flexibility, high precision and optimum productivity.

It is specifically designed to accommodate shaft pinions, mating bull gears and internal ring gears.

Extended capacity for gears and profiles is:

- Internal and external gear grinding up to 4m (160") OD x 1.5m (60") face.
- The ability to inspect lead, profile and spacing up to 4m (160")



Havlik GEAR

Div. of Havlik International Machinery Inc.

455 Sheldon Dr., Cambridge, Ontario N1T 2B7 tel 519-624-6240 fax 519-624-4119

www.havlikgear.com

All-Tech Services
(877) 344-0440
www.alltechservices.ca

Baumer Ltd. U.S.A.
(800) 937-9336
www.baumerelectric.com

Belyea Co.
(610) 515-8775
www.belyeapower.com

Beta Engineering LLC
(318) 487-9599
www.betaengineering.com

CEI Electrical Contractors
(406) 656-4365
www.cei-online.com

Christenson Electric, Inc.
(503) 419-3300
www.christenson.com

Cummings Electrical, Inc.
(817) 355-5337
www.cummingselec.com

D.A. Electric, Ltd.
(403) 328-4849
www.daelectric.com

Faith Technologies, Inc.
(913) 541-4700
www.faithtechnologies.com

GENEX Power Systems Corp.
(403) 807-9485
www.genexpower.com

Great Southwestern Construction
(303) 688-5816
www.gswc.us

G&W Electric Co.
(708) 388-5010
www.gwelec.com

H&G Electrical Services
(574) 282-2596
www.hgservices.com

Hawkeye LLC
(631) 447-3100
www.hawkeyellc.com

Henkels & McCoy, Inc.
(888) 436-5357
www.henkels.com

Hypower, Inc.
(936) 435-1547
www.hypowerinc.com

IES Industrial, Inc.
(281) 716-4068
www.ies-co.com

John Burns Construction
(708) 326-3410
www.jbconstructionco.com

K-Line Group
(905) 640-2002
www.k-line.ca

Koontz Electric Company, Inc.
(501) 354-2526 ext. 133
www.koontzelectric.com

Larkin Enterprises, Inc.
(207) 794-8788
www.larkinent.com

MasTec North America, Inc.
(800) 280-6570
www.mastec.com

Michels Corp.
(920) 583-3132
www.michels.us

Muth Electric, Inc.
(605) 996-3983
www.muthelectric.com

Pauwels Transformers
(636) 239-9300
www.pauwels.com

Pike Electric, Inc.
(512) 369-1670
www.pike.com

Power Partners MasTec LLC
(704) 329-8277
www.powerpartnersllc.com

PowerTel Utilities Contractors
(705) 866-2825
www.powertel.ca

Rauhorn Electric, Inc.
(586) 992-0400
www.rauhornelectric.com

RMT, Inc.
(608) 662-5222
www.rmtinc.com

Robinson Brothers Construction
(360) 576-5359
www.rbc-utility.com

S&C Electric Co.
(773) 338-1000
www.sandc.com

Sorensen Companies, Inc.
(801) 773-4390 ext. 247
www.gosci.com

System 3, Inc.
(916) 979-0550
www.system3inc.com

The Townsend Corporation
(765) 468-3007
www.thetownsendcorp.com

Tiltran Services, Inc.
(519) 842-6458
www.tiltran.com

Transformer Service, Inc.
(603) 224-4006
www.transformer-svc.com

U.S. Electronics, Inc.
(952) 285-5720
www.usei.com

Valley Electrical Consolidated
(330) 539-4044
www.vecohio.com

W.R. Casteel Co., Inc.
(724) 437-3672
www.wrcasteel.com

Windemuller
(800) 333-3641
www.windemuller.us

ENCLOSURES

Concast, Inc.
(507) 732-4095
www.concastinc.com

Fibox, Inc.
(410) 760-9696
www.fiboxusa.com

Highline Products
(781) 328-3220
www.highlineproducts.com

Lectrus
(800) 445-8791
www.lectrus.com

Marsh Electronics, Inc.
(800) 236-8327
www.marshelectronics.com

Oldcastle Precast Enclosures
(909) 592-6272
www.oldcastleprecast.com

PACS Industries, Inc.
(516) 829-9060
www.pacsindustries.com

Parkline, Inc.
(304) 586-2113
www.parkline.com

RLH Industries, Inc.
(714) 532-1672
www.fiberopticlink.com

ENCODERS

Encoder Products
(208) 263-8541
www.encoder.com

CST Custom Sensors
(805) 552-3599
www.cstsensors.com

Dynapar
(800) 873-8731
www.dynapar.com

Leine & Linde AB
46 152 265 00
www.leinelinde.fi

SCANCON Encoders
45 481 727 02
www.scancon.dk

Sick Stegmann
(800) 811-9110
www.stegmann.com

ENGINEERING SERVICES

ADM-Works
(714) 245-0536
www.adm-works.com

AECOM
(303) 595-4522
www.aecom.com

AMEC
(978) 692-9090 ext. 306
www.amec.com

American Superconductor
(978) 842-3000
www.amsc.com

American Technical Services
(605) 339-3722
www.americantechnicalservices.net

Ampirical Solutions LLC
(985) 809-5252
www.ampirical.com

Askew Industrial Corporation
(888) 401-3745
www.askewindustrial.com

ATI Wind (ATI Eolien)
(418) 732-2552
www.ati-eolien.com

Aubrey Silvey Enterprises, Inc.
(503) 496-3255
www.silvey.com

AVO Engineering Division
(877) 594-3559
www.electricalpowerengineering.com

Ayres Associates
(715) 834-3161
www.ayresassociates.com

AWS Truewind LLC
(518) 213-0044
www.awstruewind.com

Barr Engineering Co.
(952) 832-2600
www.barr.com

Beta Engineering LLC
(318) 487-9599
www.betaengineering.com

Bolton & Menk, Inc.
(507) 625-4171
www.bolton-menk.com

Braun Intertec Corporation
(952) 995-2000
www.braunintertec.com

C.H. Guernsey & Co.
(405) 416-8100
www.chguernsey.com

Careba Mott MacDonald
(781) 636-4125
www.power.mottmac.com

CEMCON, Ltd.
(630) 862-2100
www.cemcon.com

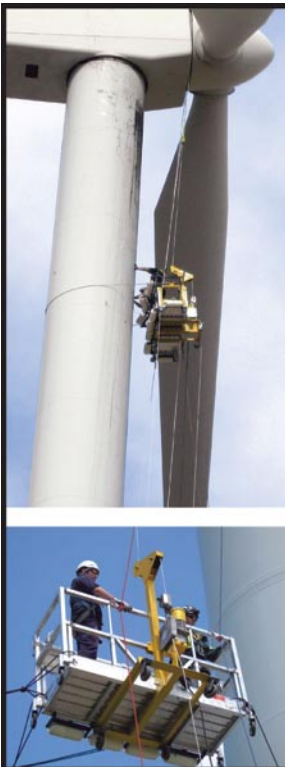

Introducing
SafAscent™
Wind Turbine Platform

Make access a breeze with the new **SafAscent™** Wind Turbine Platform for unrestricted external access to wind towers and blades.

- Modular platform with steel wind cage stirrup
- Removable tower-hugging roller system
- Easily transported with a small truck
- Exceeds OSHA, OH&S and ANSI standards
- Meets all UL and CSA requirements



Find out more at www.safway.com/wind.

ThyssenKrupp Safway, Inc.

Scaffold Rental, Sales & Services



www.safway.com/wind

ThyssenKrupp

CHA
(877) CHA-4-WIND
www.chacompanies.com

Commonwealth Associates, Inc.
(517) 788-3000
www.cai-engr.com

CTL/Thompson, Inc.
(970) 206-9455
www.ctlt.com

CUBE Engineering GmbH
49 5612885730
www.cube-engineering.com

Culver Careers
(916) 932-2360
www.culvercareers.com

DARcorporation
(785) 832-0434
www.darcorp.com

DEX
(888) 678-9201
www.dex.com

Donald Keef And Associates, Inc.
(530) 223-1413
www.dka-inc.com

EAPC
(701) 775-3000
www.eapc.net

Elcon Associates, Inc.
(503) 644-2490
www.elcon.com

Electronics Research, Inc.
(812) 925-6000
www.eriinc.com

Frontier Surveying Co.
(361) 881-8044
www.frontiersurveying.com

GAI Consultants, Inc.
(412) 476-2000
www.gaiconsultants.com

Golder Associates
(905) 567-4444
www.golder.com

GZA GeoEnvironmental, Inc.
(781) 278-3700
www.gza.com

HDR
(800) 366-4411
www.hdrinc.com

Henkels & McCoy, Inc.
(888) 436-5357
www.henkels.com

Hypower Renewable Energy
(954) 410-7266
www.hypowerinc.com

Industrial Power Technology
(707) 528-8900
www.power-tech.com

Innoventor, Inc.
(314) 785-0900
www.innoventor.net

JR2 Energy Services, Inc.
(713) 559-0150
www.jr2energy.com

Knight Piesold, Ltd.
(604) 685-0543
www.knightpiesold.com

L. Nardella Associates, Ltd.
(450) 967-1000
www.nardellagroup.com

Larson Engineering, Inc.
(920) 734-9867
www.larsonengr.com

M&S Engineering
(830) 228-5446
www.msengr.com

Max Engineering LLC
(713) 773-2525
www.wpcs.com

McMillen LLC
(208) 559-0336
www.mcmillen-llc.com

Meridian Associates, Inc.
(978) 299-0447
www.meridianassoc.com

**Mesa Associates, Inc.-Systems
Integration/SCADA**
(423) 424-7300 ext. 7459
www.mesaintegra.com

Michels Corp.
(920) 583-3132
www.michels.us

Midwest Engineering Services, Inc.
(217) 359-2128
www.midwesteng.com

Mortenson Construction
(763) 287-5489
www.mortenson.com

Northwest Utility Services LLC
(253) 891-7802
www.nwutility.com

Nova Partners, Inc.
(650) 324-5324
www.novapartners.com

P.S.D., Inc.
(330) 452-4434
www.psdohio.com

PBS&J
(512) 327-6840
www.pbsj.com

Peak Power Engineering, Inc.
(303) 462-1100
www.peakpwr.com

Pike Electric, Inc.
(512) 369-1670
www.pike.com

POWER Engineers
(208) 788-3456
www.powereng.com

Power Partners MasTec LLC
(704) 329-8277
www.powerpartnersllc.com

Power System Engineering
(608) 268-3530
www.powersystem.org

R.J. Burnside & Associates Limited
(519) 941-5331
www.rjburnside.com

**Ransom Environmental
Consultants, Inc.**
(207) 772-2891
www.ransomenv.com

Ricardo, Inc.
(734) 394-3933
www.ricardo.com

RISE Engineering
(413) 736-7473
www.thielsch.com

RMS Consulting & Training
(702) 878-8656
www.rmsconsulting.com

RMT, Inc.
(608) 662-5222
www.rmtinc.com

RRD Engineering
(970) 581-8091
www.rrdengineering.com

S&C Electric Co.
(773) 338-1000
www.sandc.com

Samuel Engineering, Inc.
(303) 714-4840
www.samuelengineering.com

Sargent & Lundy LLC
(312) 269-2000
www.sargentlundy.com

Schnabel Engineering
(336) 274-9456
www.schnabel-eng.com

SED
(585) 265-2384
www.sed-net.com

SGC Engineering LLC
(207) 347-8100
www.sgceng.com

Shannon & Wilson, Inc.
(509) 946-6309
www.shannonwilson.com

Signal Wind Energy LLC
(423) 443-4190
www.signalwind.com

Stanley Consultants
(800) 553-9694
www.stanleyconsultants.com

Stantec
(250) 655-6050
www.stantec.com

Stork Materials Technology
(888) STORK55
www.storksmt.com

Tetra Tech
www.tetrattech.com
(626) 351-4664

The Riley Group, Inc.
(509) 586-4840
www.riley-group.com

The SPE Group
(888) 773-8845
www.spepower.com

3U Technologies LLC
(936) 441-3043
www.3utech.com

Tiltran Services, Inc.
(519) 842-6458
www.tiltran.com

Trintek Energy Consultants
(630) 776-6247
www.trintek-energy.com

University of Alaska Fairbanks
(907) 474-7107
www.uaf.edu

URS Corp.
(973) 785-0700
www.urscorp.com

W.R. Casteel Co., Inc.
(724) 437-3672
www.wrcasteel.com

Westwood Professional Services
(952) 937-5150
www.westwoodps.com

White Construction, Inc.
(765) 828-2572
www.whiteconstruction.com

Willett Hofmann & Associates, Inc.
(815) 284-3381
www.willetthofmann.com

WindLogics
(651) 556-4200
www.windlogics.com

Wind Prospect, Inc.
(720) 542-9922
www.windprospect.com

Windstream Energy, Inc.
(905) 632-5757
www.windstreamenergy.ca

Woolpert, Inc.
(513) 272-8300
www.woolpert.com

FASTENERS

AA Anchor Bolt
(248) 349-6565
www.aaanchorbolt.com

AFI Industries, Inc.
(630) 462-0400 ext. 7815
www.afiindustries.com

Wind Turbine Safety & Rescue Leader's Guide

A simple, effective way to meet your OSHA training requirements.





Includes:
Fully-scripted leader's guide, Powerpoint on CD, and sample student manuals.

Introductory Price:
Leader's Guide: \$145
Workbooks: \$9.95 each

Train your workers using our proven curriculum. Specific topics include:

- Fall Protection
- Lockout Tagout
- Confined Space
- Rescue

Mastery-Level Safety and Rescue Training since 1992

Order Today Call us at 800.551.8763 or visit:

www.d2000safety.com

On-site training is also available. Call for details.

EVERLAST[®] Indestructible Signs & Tags



Signs & Tags

- 1/4" Thick
- UL Tested! 30 Years No Change!
- Underwriters Laboratories Inc.

Call For FREE CATALOG

VIP# AWND9KT

TECH PRODUCTS, INC.

1-800-221-1311
WWW.TECHPRODUCTS.COM

Askew Industrial Corp.
(323) 201-4000
www.askewindustrial.com

BBC Fasteners, Inc.
(708) 597-9100
www.bbcfasteners.com

Boker's Inc.
(800) 927-4377
www.bokers.com

Cardinal Fastener & Specialty Co.
(216) 292-1463
www.cardinalfastener.com

Chicago Industrial Fasteners
(571) 261-4321
www.chicagoindustrialfasteners.com

Cooper and Turner, Ltd.
44 (0) 114 256 0057
www.cooperandturner.co.uk

Copper State Bolt & Nut
(602) 469-6268
www.copperstate.com

DEX
(888) 678-9201
www.dex.com

DGI-MENARD, Inc.
(412) 257-2750
www.dgi-menard.com

DISC-LOCK International
(310) 944-9352
www.disc-lock.com

EGC Enterprises, Inc.
(440) 285-5835
www.rotobolt.com

Fastenal
(432) 264-1758
www.fastenal.com

Fasteners Unlimited, Inc.
(724) 776-7273
www.fastenersunlimited.com

FCI-BURNDY Products
(603) 647-5000
portal.fciconnect.com

Gexpro Services
(972) 915-1814
www.gexproservices.com

JW Winco
(800) 877-8351
www.jwwinco.com

Kerr Lakeside, Inc.
(800) 316-5377
www.kerrlakeside.com

Mudge Fasteners
(800) 634-0406
www.mudgefasteners.com

Nelson Stud Welding, Inc.
(440) 329-0400
www.nelsonstud.com

Nova Machine Products, Inc.
(216) 267-3200
www.novamachine.com

Nylok Corp.
(216) 272-4905
www.nylok.com

Portland Bolt & Manufacturing
(800) 547-6758
www.portlandbolt.com

Process Products, Ltd.
(800) 263-2977
www.process-products.com

Randack Fasteners Americas (RFA)
(847) 847-1280
www.rs-randack.de

RPM Carbide Die, Inc.
(419) 894-6426
www.rpmprecision.com

RW Supply
(580) 252-8723
www.rwsupply.net

Safety Socket LLC
(773) 763-2020
www.safetysocket.com

The Dyson Corp.
(440) 946-3500
www.dysoncorp.com

Threaded Fasteners, Inc.
(251) 432-0107
www.threadedfastenersinc.com

TurnaSure LLC
(215) 750-1300
www.turnasure.com

Valley Forge & Bolt Mfg. Co.
(602) 269-5748
www.vfbolts.com

WESCO Materials
(260) 665-6112 ext. 145
www.wescowind.com

FOUNDATIONS/ COMPONENTS

Bassett Mechanical
(920) 759-2500
www.bassettmechanical.com

Dayton Superior Corp.
(937) 428-6360
www.daytonsuperior.com

DYWIDAG Systems International
(630) 972-4036
www.dsiamerica.com

Ehresmann Engineering, Inc.
(605) 665-7532
www.ehresmannengineering.com

Fabsco Corp.
(708) 371-7500
www.fabsco.com

Foresight Products LLC
(303) 286-8955
www.earthanchor.com

Johnston Fargo Culvert, Inc.
(800) 747-3485
www.johnstonculvert.com

National Concrete Accessories
(888) 777-9272
www.nca.ca

**PAGEL-U.S.A. Industrial
Grouts & Mortars**
(952) 942-6105
www.pagel-usa.com

RCL Enterprises
(315) 677-9538
www.rclenterprises.com

Trenwa, Inc.
(859) 781-0831
www.trenwa.com

Williams Form Engineering Corp.
(616) 866-0815
www.williamsform.com

FOUNDATIONS/SYSTEMS

**Alabama Metal Industries
Corporation**
(704) 905-8864
www.amico-stayform.com

Con-Tech Systems, Ltd.
(604) 946-5571
www.contechsystems.com

Densit ApS
45 9167011
www.densit.com

Helical Technology
(303) 225-0075
www.helicaltechnology.com

Highline Products
(781) 328-3220
www.highlineproducts.com

ITW Polymer Technologies
(913) 206-1659
www.chockfastgrout.com

MacLean-Dixie
(847) 455-0014
www.macleaupower.com

Unitex
(505) 235-9991
www.unitex-chemicals.com

FOUNDATIONS/SERVICES

Advanced GeoServices Corp.
(610) 840-9100
www.advancedgeoservices.com

Cajun Industries LLC
(972) 221-3233
www.cajunusa.com

Construction Drilling, Inc.
(250) 746-4408
www.constructiondrilling.ca

Densit ApS
45 9167011
www.densit.com

Epoxy Design Systems
(713) 461-8733
www.epoxydesign.com

GAI Consultants, Inc.
(412) 476-2000
www.gaiconsultants.com

Geopier Foundation Co.
(704) 799-3185
www.geopier.com

Hayward Baker, Inc.
(800) 456-6548
www.haywardbaker.com

Industrial Piping & Steel
(361) 884-1677
www.industrialpipingandsteel.com

Michels Corp.
(920) 583-3132
www.michels.us

Mortenson Construction
(763) 287-5489
www.mortenson.com

Nicholson Construction Company
(412) 221-4500
www.nicholsonconstruction.com

Norm Tooman Construction, Inc.
(800) 359-0372
www.normtoomanconst.com

Reinforcing Services Co.
(260) 694-6254
www.reinforcingservices.com

Subsurface Constructors, Inc.
(866) 421-2460
www.subsurfaceconstructors.com

Tensar International Corp.
(888) TENSAR-1
www.tensar-international.com

Wanzek Construction-a MasTec Company
(701) 282-6171
www.wanzek.com

Whaley Red Star Steel
(260) 694-6254
www.whaleyredstar.com

HEAVY EQUIPMENT

Barreto Manufacturing, Inc.
(541) 963-7348
www.barretomfg.com

Cashman Equipment Co.
(800) 937-2326
www.cashmanequipment.com

Ditch Witch
(800) 654-6481
www.ditchwitch.com

RSC Equipment Rental
(800) 222-7777
www.rscrental.com

Elk River, Inc.
Personal Fall Protection

Soar to new heights with our...

NEW WindEagle™ LE Harness 62450,
Aluminum TX-12 Flex-NoPac®
Rescue Ring (CSA E6),
Energy-Absorbing
Lanyard 35689, and
*EZE-Man™ Auto Descent
Rescue Device with Hub

**Professional Training Required*

elkriver.com 800.633.3954

THREADED FASTENERS, INC.
ISO 9000 Certified

Manufactured
Anchor Bolts
To Meet Your
Specifications:
F1554, A449
& A307 GR C

» A394
Tower
Bolts

» A325
Structural
Bolts

800.345.4976
threadedfastenersinc.com

FASTENER SOLUTIONS FROM THE GROUND UP

Scott-Macon Equipment
(713) 721-7070
www.smequipment.com

Stevenson Crane Service
(630) 972-9199
www.stevensoncrane.com

Tesmec U.S.A., Inc.
(817) 473-2233
www.tesmec.com

Trench Grader
(870) 697-2226
www.trenchgrader.com

Warren Cat
(432) 571-4201
www.warrencat.com

METEOROLOGICAL TOWERS

AAT, Inc.
(418) 360-1228
www.aat-solutions.com

Anemometry Specialists, Inc.
(712) 200-2281
www.anemometry.com

**GiMSA Structural
Manufacturing**
52 (866) 649-4200
www.gstm.com.mx

NRG Systems
(802) 482-2255
www.nrgsystems.com

R&J Services
(307) 399-1517
www.rjsrv.com

Sabre Towers and Poles
(800) 369-6690
www.sabretowersandpoles.com

Turriscorp.
(905) 461-9699
www.turriscorp.com

TWR Lighting, Inc./Orga Aviation
(713) 973-6905 ext. 116
www.twrlighting.com

**METEOROLOGICAL
TOWERS/INSTALLATION**

Anemometry Specialists, Inc.
(712) 200-2281
www.anemometry.com

DNV Global Energy Concepts
(206) 387-4200
www.globalenergyconcepts.com

GENIVAR Wind
(512) 426-1030
www.genivarwind.com

GPCo
(866) 929-0062
www.gpcoenergy.com

Harness Energy LLC
(970) 376-5468
www.harnessenergyllc.com

Hi-Tech Towers, Inc.
(217) 784-5212
www.hi-techtowers.com

Invenergy
(312) 506-1474
www.invenergyllc.com

Karbon Zero
(505) 821-6654
www.karbonzero.com

KB Energy Co.
(307) 378-3480
www.kbenergy.com

**YOUR FIRST STEP IN
HARVESTING THE WIND...**



Professional tilt up met tower installs,
repair, leasing, Sodar relocation



www.kbenergy.com

HC 64 Box 200 | 1704 State Hwy 13 | Arlington, WY 82083
Office: 307-378-3480 | Fax: 307-378-2100

**JPW
RIGGERS**

**ONE OF THE
LARGEST FLEETS OF
MANITOWOC
16000'S
IN THE COUNTRY**

**16000
2250
999
14000**

Dave 800.724.0937
Cell 315.374.5912
WWW.JPWRIIGGERS.COM

Lapp Group provides Cable and Accessory Solutions for Wind Turbines



**NEW!
Product**

Lapp introduces OLFLEX® FORTIS, our highest performance UL-listed tray cable. OLFLEX® FORTIS is named after the Latin word meaning “strength”. It offers outstanding mechanical performance, particularly at low temperatures. The specially formulated elastomeric jacket passes UL’s -40°C cold impact test. OLFLEX® FORTIS also offers outstanding oil resistance (UL OIL RES I & II) and meets all Tray Cable (UL-1277) and Wind Turbine Tray Cable (UL-2277) requirements.

Technical Specifications:

- -40°C Flexible/ -55°C Stationary
- UL-1277
- UL AWM 21098
- UL OIL RES I & II
- CSA C22.2 No. 230
- FT4 Flame resistance

OLFLEX® FORTIS P/N 331404- 14 AWG (2.50MM²)/4C (UL)TYPE TC-ER THHN/ THWN 90°C DRY 75°C WET 600V, SUN RES, OIL RES I/II E171371 or MTW “FLEXING” or WTTC 1000V 90°C DRY, or c(UL) CONTROL CIC/TC PVC -40°C OUTDOOR FT4 -- CSA AWM II A/B 90°C 600V FT4 CE ROHS

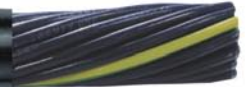

Lapp offers products and solutions for wind turbines from the nacelle down through the tower.

OLFLEX® cables are the industry’s largest selection of high quality cables to meet UL-2277 Wind Turbine Tray Cable (WTTC) requirements for tower wiring.

Our product range includes data/bus cables for 600V, 300V (CMG) and fiber optic data transmission.

Lapp offers a wide variety of plastic and metal cable glands for sealing and strain relief in equipment and enclosures. We also offer a wide range of industrial EPIC® connectors for use in wind turbine applications.



1-888-456-3539
www.lappusa.com



LAPP GROUP

Mariah Resources, Inc.
(800) 619-0845
www.mariahresources.com

Ontario Windsmith, Inc.
(519) 395-2621
www.ontariowindsmith.com

Sentrex Wind Services, Inc.
(506) 849-0026
www.sentrexwind.com

Turriscorp.
(905) 461-9699
www.turriscorp.com

WINData, Inc.
(406) 727-1014
www.windata-inc.com

NETWORKING

Amphenol Fiber Systems International
(214) 547-2400
www.fibersystems.com

Arcadian Networks
(914) 579-6300
www.arcadiannetworks.com

FreeWave Technologies
(303) 381-9200
www.freewave.com

Hirschmann Automation
(717) 217-2200
www.hirschmann.com

MSI Tec, Inc.
(720) 875-9835
www.msitec.com

N-TRON
(251) 342-2164
www.n-tron.com

Panduit Corp.
(708) 532-1800
www.panduit.com

Sixnet LLC
(518) 877-5173
www.sixnet.com

OCEAN SHIPPING SERVICES

Bellville Rodair International
(713) 921-5544
www.briusa.com

Blue Water Shipping U.S., Inc.
(310) 352-4300
www.bws.dk

PORTS/TERMINALS

Duluth Seaway Port Authority
(218) 727-8525
www.duluthport.com

Manly Logistics Park
(319) 415-8150
www.iowanorthern.com

Midwest Terminals of Toledo
(419) 698-8171
www.midwestterminals.com

Novatech APS
45 98165009
www.novatech.dk

Port of Albany
(732) 390-1711
www.portofalbany.com

Port of Coos Bay
(541) 267-7678
www.portofcoosbay.com

Custom Spray Booths



Available in all sizes!

Global Finishing Solutions (GFS) specializes in building custom spray booths, ovens and finishing systems for liquid and powder coating of large equipment. Many companies that manufacture wind towers, blades and castings are satisfied customers.

Call for details today.



WWW.GLOBALFINISHING.COM

800.848.8738

Port of Corpus Christi
(800) 580-7110
www.portofcorpuschristi.com

Port of Lake Charles
(337) 439-3661
www.portlc.com

Port of Longview
(360) 425-3305
www.portoflongview.com

Port of San Francisco
(415) 274-0488
www.sfgov.org

Port of Stockton
(209) 946-0246
www.portofstockton.com

Port of Vancouver U.S.A.
(360) 693-3611
www.portvanusa.com

Ports America
(732) 635-3899
www.portsamerica.com

Union Pacific Carrier Services
(800) 550-9227
www.upds.com

Waterson Terminal Services
(401) 461-9900
www.provport.com

POWER CONDITIONING EQUIPMENT

Arteche PQ, Inc.
(262) 754-3883
www.artechepq.com

Mangoldt Reactors
(414) 354-8747
www.mangoldt.com

Northeast Power Systems
(518) 792-4776
www.nepsi.com

Parker Hannifin-SSD Drives
(704) 588-3246
www.ssddrives.com

Phase Technologies
(605) 343-7934
www.phasetechnologies.com

Power Magnetics, Inc.
(609) 695-1170
www.powermagneticsinc.com

S&C Electric Co.
(773) 338-1000
www.sandc.com

United Chemi-Con Corp.
(847) 696-2000
www.chemi-con.com

**POWER METERING/
RELAYING EQUIPMENT**

Beckwith Electric Co.
(727) 544-2326
www.beckwithelectric.com

Carter & Crawley, Inc.
(864) 288-6250
www.cartercrawley.com

Elspec North America, Inc.
(815) 266-4210
www.elspec-ltd.com

LEM U.S.A.
(414) 353-0711
www.lem.com

Marsh Electronics, Inc.
(800) 236-8327
www.marshelectronics.com

Rodan Energy & Metering, Inc.
(905) 625-9900
www.rodanpower.com

ZIV U.S.A., Inc.
(847) 299-6580
www.zivusa.com

POWER STORAGE

ClearSpan-a division of TekSupply
(800) 835-7877
www.teksupply.com

Stahlwille Tools is the ONLY tool company with dimensionally accurate hand tools!

STAHLWILLE

TORQUE WRENCHES

- Super accurate scale designed for industrial applications
- Can be used as a breaker bar with no damage
- Designed to ISO 12 month calibration cycle
- Does not need to be "zero'd" after use
- Interchangeable insert heads

MOBILE TORQUE TESTERS

**STAHLWILLE TOOLS NA. SARASOTA FL. 800-695-2714
WWW.STAHLWILLETOOLS.COM**

Dynapower Corp.
(800) 292-6792
www.dynapower.com

Energy Storage and Power LLC
(908) 393-7177
www.energystorageandpower.com

Exide Industrial Energy
(800) 268-2698 ext. 215
www.exide.com

Inland Tarp & Cover, Inc.
(800) 346-7744
www.inlandtarp.com

WTEC
(201) 242-9906
www.windnenergy.com

ZBB Energy Corp.
(262) 253-9800
www.zbbenergy.com

PROJECT DUE DILIGENCE

Aero Solutions LLC
(720) 381-2854
www.aerosolutionsllc.com

Altus Group
(416) 227-7039
www.altusgroup.com

AMEC
(905) 829-5400
www.amec.com

Atlantic Wind Energy LLC
(757) 401-9604
www.atlanticwindenergy.net

AWS Truewind LLC
(518) 213-0044
www.awstruewind.com

DNV Global Energy Concepts
(206) 387-4200
www.globalenergyconcepts.com

Garrad Hassan America, Inc.
(858) 836-3370
www.garradhassan.com

Garrad Hassan Canada, Inc.
(613) 230-3787
www.garradhassan.com

GENIVAR Wind
(512) 426-1030
www.genivarwind.com

Helimax Energy
(514) 272-2175
www.helimax.com

Project Risk, Ltd.
(615) 264-6282
www.projrisk.com

Sigma Energy Solutions, Inc.
(631) 420-3214
www.sigenergy.com

Spin Trends LLC
(509) 394-2663
www.spintrends.com

T-Group, Inc.
(219) 465-7414
www.tgroupinc.biz

Taos Wind Power, Inc.
(575) 751-9463
www.taoswindpower.com

Tierra Right of Way Services
(520) 319-2106
www.tierra-row.com

White Construction, Inc.
(765) 828-2572
www.whiteconstruction.com

Wind Prospect, Inc.
(720) 542-9922
www.windprospect.com

RAILROADS

Canadian Pacific
(403) 319-7487
www8.cpr.ca

CN
(514) 399-5633
www.cn.ca

CSX Transportation
(904) 359-1581
www.csx.com

Union Pacific Carrier Services
(800) 550-9227
www.upds.com

SUBSTATIONS

ABB, Inc.
(800) 435-7365
www.abb.us

Albarrie Geocomposite, Inc
(705) 737-0551
www.albarrie.com

American Wire Group
(800) 342-7215
www.buyawg.com

Beta Engineering LLC
(318) 487-9599
www.betaengineering.com

Border States Electric
(763) 315-9422
www.borderstateselectric.com

Champion Charter
(989) 773-6967
www.champion-charter.com

Concast, Inc.
(507) 732-4095
www.concastinc.com

Delta Star Connector Co.
(847) 439-4122
www.deltastarconnectorcompany.com

DIS-TRAN Packaged Substations
(318) 448-0274
www.distran.com

Dynamic Ratings
(262) 746-1230
www.dynamicratings.com

Hamby Young
(800) 726-8444
www.hambyyoung.com

HBI Associates, Inc.
(806) 352-4960
www.hbiassociates.com

Henkels & McCoy, Inc.
(888) 436-5357
www.henkels.com

HVB AE Power Systems, Inc.
(770) 495-1755
www.hvbi.com

Keystone Electrical
(515) 661-2775
www.keystoneemc.com

KVA Supply Co.
(303) 217-7510
www.kvasupply.com

MSE Power Systems, Inc.
(518) 452-7718
www.msepower.com

MVA Power, Inc.
(450) 589-0445
www.mvpower.com

PACS Industries, Inc.
(516) 829-9060
www.pacsindustries.com

PAResources Substation
(414) 258-2366
www.electricalsubstations.com

Southern States LLC
(770) 946-4562
www.southernstatesllc.com

Thomas & Betts-Utility Group
(901) 252-5231
www-public.tnb.com

Trachte, Inc.
(608) 835-5707
www.trachteusa.com

Energy Storage and Power LLC

SECOND GENERATION COMPRESSED
AIR ENERGY STORAGE ("CAES2")
TECHNOLOGIES ARE PATENTED BY DR.
NAKHAMKIN AND LICENSED BY ES&P.

ES&P PARTICIPATES IN ALL STAGES OF CAES2 PROJECTS EXECUTION FROM CONCEPTUAL
ENGINEERING AND OPTIMIZATION TO DELIVERY OF PLANTS ON TURNKEY BASIS.

SECOND GENERATION CAES2 PRIME FEATURES:

- Provides Load Management of Renewable Energy and Optimization of Smart Grid
- Totally Green Energy Storage Cycle with ~ 90% Efficiency
- Scalable from 15 MW to 430 MW
- Total energy delivered with Heat Rate Less than 3,800 Btu/kWh
- Bottoming Cycle Green Power is ~ 150-200% of CT Capacity
- Above- and Below-Ground Compressed Air Storage
- Less Expensive than Combined Cycle (CC) Power Plant

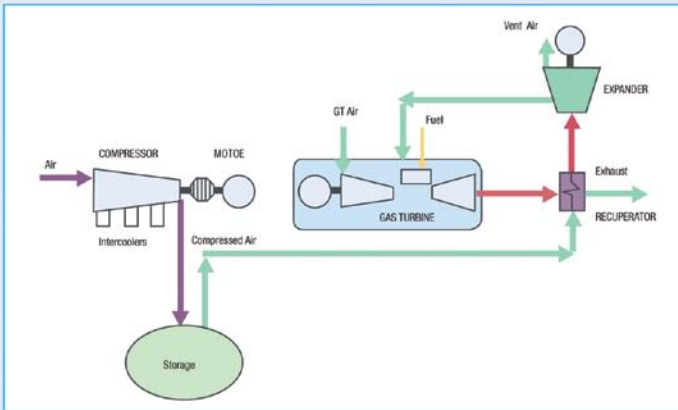

ES&P IS THE ONLY
COMPANY THAT
WAS INVOLVED
IN ALL STAGES OF
EXECUTION OF THE
110 MW CAES
PROJECT- THE ONLY
CAES PROJECT IN
THE US.

CONTACTS:

ROY DANIEL (Chief Operating Officer)
rdaniel@energystorageandpower.com

STEPHEN BYRD (Chief Executive Officer)
sbyrd@energystorageandpower.com

MAIN OFFICE NUMBER: 908-393-7177
www.EnergyStorageAndPower.com
infoEnergyStorageAndPower.com

Valmont Newmark
(205) 968-7200
www.valmont.com

SWITCHES/SWITCHGEAR

ABB, Inc.
(800) 435-7365
www.abb.us

Acorn Technology Corp.
(216) 663-1244
www.acorntechnology.com

**AZZ-Central Electric
Manufacturing Company**
(573) 642-6811
www.poweraisle.com

AZZ Blenkhorne & Sawle, Ltd.
(905) 684-9251
www.blenksawle.com

Concast, Inc.
(507) 732-4095
www.concastinc.com

Federal Pacific
(276) 669-4084
www.federalpacific.com

G&W Electric
(708) 388-5010
www.gwelec.com

Marsh Electronics, Inc.
(800) 236-8327
www.marshelectronics.com

PACS Industries, Inc.
(516) 829-9060
www.pacsindustries.com

S&C Electric Co.
(773) 338-1000
www.sandc.com

The Tagos Group LLC
(713) 625-7531
www.tagosgroup.com

Thomas & Betts-Utility Group
(901) 252-5231
www-public.tnb.com

THIRD-PARTY LOGISTICS

Aero Logistics
(650) 266-6982
www.aerologistics.com

American Transport, Inc.
(334) 702-1753
www.transportinvestments.com

BDP Project Logistics
(281) 233-4777
www.bdpprojects.com

Blue Water Shipping U.S., Inc.
(310) 352-4300
www.bws.dk

CH Robinson Worldwide, Inc
(800) 473-0136
www.chrobinson.com

DEX
(888) 678-9201
www.dex.com

Lugo Marine International
(713) 906-3698
www.lugomarine.com

Sotech Nitram
(450) 975-2100
www.sotechnitram.com

TMO Global Logistics
(434) 923-3375
www.tmogloballogistics.com

This...

... Won't happen without Us!

**INDUSTRIAL
PIPING
& STEEL**

Ph: 361-884-1677
Fx: 361-884-0430

Fabricated Rebar & Structural Steel
www.Industrialpipingandsteel.com

**THERE IS ONLY ONE THERMION
AND WE'VE GONE GREEN**

**Thermion, the industry standard for
High Production Metalizing System.**

Better DE or Deposit Efficiency than other model spray units thus maximizing the energy used and minimizing waste.

Low energy consumption with higher output capabilities.

Lowering life cycle cost thru Twin Wire Arc Spray.

AND its by-product is recyclable.

Thermion has been inventing, manufacturing and selling arc spray equipment for over 30 years. We offer full service capabilities to include:

- Training
- Consumables
- Spray Wires
- Service
- Tech Support
- Engineering

Thermion™
The Original and Reliable
www.thermioninc.com
360.692.6469 • info@thermioninc.com

Coming Soon
Iowa Wind Service Center

We planted these.



Turner Bros. can make planting a wind farm a breeze. We can move your components in any direction. Down the road. Up in the air. Exactly where and when you want it.

Our services include transportation, construction, mechanical completion and maintenance—bringing together people and equipment to manage and move your components with the accuracy and precision you expect. Turner Bros. has the experience you need for success. We have installed over 1,000 megawatts.

Turner Bros. is your one stop source for transportation and lifting solutions in the wind power industry.

Turner Bros.—bringing you safety, performance, and experience to get the job done right.



Turner Bros., LLC

www.TurnerBros.com



Construction

Maintenance

Transportation

Crane & Rigging

Technicians



LONGVIEW ◦ 5533 South FM 2087 ◦ Longview, TX 75603 ◦ 800-666-1723

ABILENE ◦ 11424 Hwy 277 S ◦ Hawley, TX 79525 ◦ 325-260-0012

HOUSTON ◦ 15730 Beaumont Hwy ◦ Houston, TX 77049 ◦ 800-666-6617

TransGroup Worldwide Logistics
(281) 219-1500
www.transgroup.com

Transera International Logistics, Ltd.
(403) 295-1505
www.transera-intl.com

Translink, Inc.
(918) 495-1237
www.translinkinc.com

Union Pacific Carrier Services
(800) 550-9227
www.upds.com

Vectora Transportation
(773) 661-2267
www.vectoratransportation.com

TOOL/EQUIPMENT LEASING

Bolttech-Mannings
(724) 872-4873
www.bolttech.com

CEJN Industrial Corp.
(224) 430-0173
www.cejn.com

Mersino
(810) 658-3472
www.mersino.com

MobileCal
(866) 384-3010
www.mobilecal.net

Northeast Industrial Bolting & Torque
(484) 951-6628
www.nibtorque.com

TOOLS/TENSIONING

Alltite
(316) 686-3010
www.alltite.net

Applied Bolting Technology
(800) 552-1999
www.appliedbolting.com

Atlas Copco
(248) 373-3000
www.atlascopco.us

Aztec Bolting Services, Inc.
(281) 338-2112
www.aztecbolting.com

Boltight, Ltd.
44 08708636414
www.boltight.com

Carter Diamond Tool Corp.
(800) 628-8665
www.carterdiamond.com

Chicago Pneumatic Tool Company LLC
www.cp.com

Desoutter Tools
(248) 348-6280
www.desouttertools.com

Enerpac
(800) 433-2766
www.enerpac.com

Engineering Services, Inc.
(847) 922-5645
www.astech-hydraulik.com

Engineering Services, Inc. (ESI)
(847) 847-1280
www.rs-randack.de

Gedore/Klann Tools
(843) 225-5015
www.gedoreklann.com

HD Electric Co.
(847) 473-4980
www.hdelectriccompany.com

Hydratight
(661) 972-9257
www.hydratight.com

Hydraulic Power, Inc.
(866) 436-3772
www.hydraulicpowerinc.com

HYTORC of Minnesota
(763) 263-3885
www.hytorc.com

INTEGRA Technologies
(713) 920-2400
www.integrattech.com

ITH Engineering, Inc.
(815) 363-4900
www.ith.de

Jetyd Corporation
(201) 343-4570
www.jetyd.com

Jones Hydraulic Service
(713) 674-9571
www.joneshydraulic.com

KLANN Tools, Inc.
(843) 225-5015
www.gedore.com

KT Pro Tools
(877) 708-6657
www.ktprottools.com

McCann Equipment, Ltd.
(514) 636-6344
www.torquetools.com

Millennium Torque & Tensioning
(724) 229-5020
www.milltorc.com

MobileCal
(866) 384-3010
www.mobilecal.net

Norbar Torque Tools, Inc.
(440) 953-1180
www.norbar.com

Norbar U.S.A.
(386) 774-1184
www.norbar-usa.com

Norwolf Tool Works, Inc.
(201) 666-6655
www.norwolf.com

Power Team-an SPX Brand
(800) 541-1418
www.powerteam.com

RAD Torque Systems
(604) 852-0405
www.radtorque.com

Stahlwille Tools N.A., Inc.
(800) 695-2714
www.stahlwilletools.com

Tentec, Ltd.
44 01215241990
www.tentec.net

Titan Technologies International, Inc.
(281) 449-9994
www.titanti.com

TorcUP
(888) TORCUP-1
www.torcup.com

Torkworx LLC
(888) 502-WORX
www.torkworx.com

Torqlite
(713) 983-7171
www.torqlite.com

Transcat
(800) 547-4515
www.transcat.com

Ultra Torq Hydraulic Bolting
(450) 562-9449
www.ultratorq.com

Wind Turbine Tools, Inc.
(406) 362-4449
www.windturbinetools.com

TRUCKING SERVICES

American Transport, Inc.
(334) 702-1753
www.transportinvestments.com

Anderson Haulage Limited
(800) 387-4397
www.andersonhaulage.com

ATS Wind Energy Services
(877) 556-9420
www.atswes.com

B&K Trucking
(763) 420-0055
www.bk-trucking.com

Badger Transport Systems-Broadwind Energy
(715) 823-5426
www.badgetransportinc.com

Bennett Motor Express LLC
(800) 866-5500
www.bennettig.com

Big Freight Systems, Inc.
(204) 475-8310
www.bigfreight.com

Blitz Transportation Services
(253) 320-0731
www.blitztransport.com

SUFFERING FROM

TENSION?

TAKE TWO...
CALL ME...



Foundation Tensioners
Tower Flange Tensioners
Gear Box Tensioners
Blade Bolt Tensioners



24/7/365

PROMPT SERVICE

WHEN THE WORK IS

CRITICAL

TECH SUPPORT STAFF

LEADERS IN THE TORQUE AND TENSION INDUSTRY



Bolting.com

1-800-233-8675

www.bolting.com

520 Dallas Street League City, TX 77573 Ph: 281-338-2112 Fax: 281-332-1780

TORQUE TENSION CALIBRATION PRODUCTS SERVICES

Branded Trailer Sales
(888) 445-2301
www.brandedtrailersales.com

Combined Transport, Inc.
(800) 547-2870
www.combinedtransport.com

Doug's Tug, Inc.
(562) 861-2345
www.dougstug.com

E.W. Wylie Corporation
(800) 437-4132
www.wylietrucking.com

FTI/Bill Thompson Transport, Inc.
(678) 492-1193
www.loadfti.com

Great Lakes Heavy Haul
(616) 726-1399
www.greatlakesheavyhaul.com

Hard Rock Specialized LLC
(866) 248-4275
www.windenergytransport.com

Hound Dog Transportation Services Agency LLC
(269) 217-3458
www.hounddogtransportation
services.landstaragent.com/

International Specialized Trailer Mfg. LLC
(320) 593-0860
www.isttrailers.com

JPW Riggers
(800) 724-0937
www.jpwriggers.com

Kalyn Siebert
(254) 865-7235
www.heiltrailer.com

Landstar Ranger-IDA
(208) 845-2552

LoneStar Transportation LLC
(800) 541-8271
www.lonestar-llc.com

Mattracks
(218) 436-7000
www.mattracks.com

Moonlight Transport-Independent Landstar Agent
(317) 839-8083

Peerless Limited
(866) 657-2662
www.peerless.ca

Prairie Trailer
(320) 589-1771
www.ptrailer.com

The Waggoners Trucking
(800) 888-8070
www.waggonerstrucking.com

Thru-Way Trailers
(905) 875-4611
www.thruwaytrailers.com

Trans-United, Inc.
(877) 762-3111
www.transunited.com

Turner Bros. LLC
(800) 666-1723
www.turnerbros.com

Union Pacific Carrier Services
(800) 550-9227
www.upds.com

United Specialized Trailers
(877) 376-0017
www.us-trailers.com

Watson & Chalin Mfg.
(972) 547-6020
www.watsonsuspensions.com

Wind Energy Logistics LLC
(515) 367-3108
www.windenergylogisticsllc.com

W.I.S. Logistics
(877) 947-0908
www.wislogistics.com

TRANSFORMERS

ABB, Inc.
(800) 435-7365
www.abb.us

Concast, Inc.
(507) 732-4095
www.concastinc.com

Cooper Power Systems
(800) 277-4636
www.cooperpower.com

Dynapower Corp.
(800) 292-6792
www.dynapower.com

Fortune Electric Co., Ltd.
(724) 346-2722
www.fortune.com.tw

Global Power Supply
(805) 683-3828
www.pwrgen.globalpwr.com

Instrument Transformer Equipment Corp. (ITEC)
(704) 282-4331
www.itec-ctvt.com

Jinpan International U.S.A., Ltd.
(201) 227-0680
www.jstusa.net

LakeView Metals, Inc.
(847) 838-9800
www.lvmetals.com

MTC Transformers
(276) 228-7943
www.mtctransformers.com

Power Magnetics, Inc.
(609) 695-1170
www.powermagneticsinc.com

Powertronix
(650) 345-6800
www.powertronix.com

Virginia Transformer Corp.
(540) 345-9892
www.vatransformer.com

Waukesha Electric Systems
(262) 547-0121
www.waukeshaelectric.com

WEG Electric Corp.
(678) 249-2000
www.wegtransformers.com

Weldy-Lamont Associates, Inc.
(847) 398-4510
www.weldy-lamont.com

TRANSMISSION TOWERS

Bell Lumber & Pole
(651) 633-4334
www.blpole.com

Brooks Manufacturing Co.
(360) 733-1700
www.brooksmfg.com

DIS-TRAN Steel Pole
(318) 448-0274
www.distran.com

FWT, Inc.
(817) 255-3060
www.fwtinc.com

Henkels & McCoy, Inc.
(888) 436-5357
www.henkels.com

McFarland Cascade Co.
(800) 426-8430
www.ldm.com

Pelco Structural LLC
(918) 283-4004
www.pelcostructural.com

ReliaPOLE Solutions, Inc.
(281) 259-7000
www.reliapole.com

Sabre Tubular Structures
(866) 254-3707
www.sabretubularstructures.com

Thomas & Betts Steel Structures Division
(901) 252-8115
www.tnb.com

Valmont Newmark
(205) 968-7200
www.valmont.com

WINDFARM DESIGN/MAPPING

AWS Truewind LLC
(518) 213-0044
www.awstruewind.com

CADWRX.COM
(817) 453-6488
www.cadwrx.com

DAS Surveying & Mapping
(214) 349-2200
www.dasmaps.com

Emergent Energy Group LLC
(617) 764-0206
www.emergentgroup.com

Eurus Energy America
(858) 638-7115
www.eurus-energy.com

GAI Consultants, Inc.
(412) 476-2000
www.gaiconsultants.com

GENIVAR Wind
(512) 426-1030
www.genivarwind.com

Helimax Energy
(514) 272-2175
www.helimax.com

Mapmaker Photogrammetric Services
(802) 527-9904
www.3dmapping.net

Penn Energy Trt LLC
(610) 668-0300
www.pennrealestategroup.com

Renewable Energy Systems Americas
(303) 439-4200
www.res-americas.com

ReSoft, Ltd.
44 1608730707
www.resoft.co.uk

RMT, Inc.
(608) 662-5222
www.rmtinc.com

S. Nelson & Associates
(770) 505-8566
www.s-nelson.com

Tetra Tech
www.tetrattech.com

Upwind Solutions
(541) 607-0755
www.upwindsolutions.com

Westlake Consultants, Inc.
(503) 684-0652
www.westlakeconsultants.com

Westwood Professional Services
(952) 937-5150
www.westwoodps.com

WIND RESOURCE FORECASTING/ASSESSMENT

3TIER
(206) 325-1573
www.3tier.com

AL-PRO GmbH & Co. KG
49 3669860
www.al-pro.de

Anemometry Specialists, Inc.
(712) 200-2281
www.anemometry.com

AWS Truewind LLC
(518) 213-0044
www.awstruewind.com

CEATI International, Inc.
(514) 866-5377
www.ceati.com

CPP
(970) 221-3371
www.cppwind.com

Dantec Dynamics, Inc.
(201) 236-2466
www.dantecdynamics.com

DNV Global Energy Concepts
(206) 387-4200
www.globalenergyconcepts.com

EAPC Wind Energy Services
(802) 649-1511
www.eapcwindenergy.com

Garrad Hassan Canada, Inc.
(613) 230-3787
www.garradhassan.com

GENIVAR Wind
(512) 426-1030
www.genivarwind.com

Harness Energy LLC
(970) 376-5468
www.harnessenergyllc.com

Heston Wind
(414) 265-6170
www.hestonwind.com

Integrated Environmental Data
(518) 872-2495
www.iedat.com

KB Energy Co.
(307) 378-3480
www.kbenergy.com

Kintech Engineering
34 976221789
www.kintech-engineering.com

In a perfect world, you would only need one hand to install a wind turbine.

IN A HYTORC® WORLD YOU ONLY NEED ONE TOOL

THE NEW AVANTI-WIND TORQUE TENSION MACHINE

BLADE BOLTS - GEAR SUSPENSION - TOWER BOLTS - MAIN BEARING - ROTOR ASSEMBLY - SHRINK RING

24 HOUR LIVE SUPPORT:
1-800-FOR-HYTORC
(international: +1-201-512-9500)

EMAIL: WIND@HYTORC.COM • VISIT: WWW.HYTORC.COM

M.K. Ince and Associates, Ltd.
(905) 689-3900
www.mkince.ca

Metedyn
33 0240710505
www.metedyn.com

METLogics Consulting, Inc.
(250) 851-9463
www.metlogics.com

NRG Systems
(802) 482-2255
www.nrgsystems.com

Otech Engineering
(530) 757-2264
www.otechwind.com

Sander + Partner
41 31 961 2565
www.sander-partner.ch

The Renaissance Group
(440) 946-0494
www.conservefirst.com

TheWindWay
(224) 217-7494
www.thewindway.com

**Vermont Environmental Research
Assoc., Inc. (VERA)**
(802) 244-7522
www.northeastwind.com

WindSim Americas
(781) 826-0966
www.windsim.com

WIND SENSING EQUIPMENT

Airmar Technology Corporation
(603) 673-9570
www.airmartech.com

Anemometry Specialists, Inc.
(712) 200-2281
www.anemometry.com

Arklay S. Richards Co., Inc.
(617) 527-4385
www.asrichards.com

**Atmospheric Research &
Technology**
(808) 329-1627
www.sodar.com

Atmospheric Systems Corp.
(661) 294-9621
www.minisodar.com

AWS Truewind LLC
(518) 213-0044
www.awstruewind.com

Climatronics Corporation
(631) 567-7300
www.climatronics.com

Leosphere
33 169358856
www.leosphere.com

Met One Instruments, Inc.
(541) 471-7111
www.metone.com

NRG Systems
(802) 482-2255
www.nrgsystems.com

PP Systems
(978) 834-0505
www.ppsystems.com

REMTECH, Inc.
(303) 772-6825
www.remtechinc.com

Scintec Corp.
(770) 887-0557
www.scintec.com

SecondWind, Inc.
(617) 776-8520
www.secondwind.com

Sky Power International LLC
(864) 843-4420
www.skypowerinternational.com

Spectrum Sensors and Controls
(530) 273-4608
www.specsensors.com

WIRE/CABLE

A-D Technologies
(800) 847-7661
www.adtechnologies.com

ABB, Inc.
(800) 435-7365
www.abb.us

ACA Conductor Accessories
(864) 433-0333
www.acasolutions.com

Allcable
(303) 961-1150
www.allcableco.com

Allied Wire & Cable
(484) 928-6700
www.awcwire.com

Alpha Wire
(800) 522-5742
www.alphawire.com

American Wire Group
(800) 342-7215
www.buyawg.com

Anixter
(800) 468-6267 ext. 37921
www.anixter.com

Barreto Manufacturing, Inc.
(541) 963-7348
www.barretomfg.com

Border States Electric
(763) 315-9422
www.borderstateselectric.com

Calvert Wire & Cable
(847) 707-3205
www.calvert-wire.com

Cobra Wire & Cable, Inc.
(215) 674-8773
www.cobrawire.com

CommScope
(828) 323-4936
www.commscope.com

CSS International Corp.
(201) 767-5755
www.cssic.com

Draka Cableteq U.S.A.
(501) 425-4225
www.drakausa.com

DSG-Canusa
(416) 744-5830
www.dsgcanusa.com

ECS-Electrical Cable Supply, Ltd.
(866) 218-2251
www.ecswire.com

EECOL Electric
(403) 253-1952
www.eecol.com

FIS-Fiber Instrument Sales
(315) 736-2206
www.fiberinstrumentsales.com

General Cable
(847) 458-4272
www.generalcable.com

HDW Electronics
(610) 861-8862
www.hdwelectronics.com

HELUKABEL Wire & Cable U.S.A., Inc.
(847) 930-5118
www.helukabel.com

HUBER+SUHNER, Inc.
(802) 878-0555
www.hubersuhnerinc.com

Karish Electronics
(714) 516-1852
www.karishselectro.com

Lubrizol
(440) 943-4200
www.lubrizol.com

Lutze, Inc.
(704) 504-0222
www.lutze.com

Mid-State Supply Company LLC
(800) 738-8300
www.midstatesupply.com

MP Husky LLC
(864) 234-4800
www.mphusky.com

Northwire, Inc.
(715) 294-2121
www.northwire.com

OFS
(770) 798-4000
www.ofsoptics.com

Paige Electric
(800) 997-2443 ext. 225
www.paigeelectric.com

Preformed Line Products
(440) 461-5200
www.preformed.com

Priority Wire & Cable, Inc.
(800) 945-5542
www.prioritywire.com

Prysmian Cables & Systems
(803) 951-4889
www.prysmianusa.com

State Electric Supply Co.
(800) 624-3417
www.stateelectric.com

Synergy Cables U.S.A., Ltd.
(770) 226-9898
www.synergycables.com

Tele-Fonika Cable Americas
(630) 406-9000
www.tfcable.com

The Okonite Co.
(763) 432-3818
www.okonite.com

The Valley Group-a Nexans Co.
(203) 431-0262
www.nexans.us

TPC Wire and Cable
(800) 521-7935
www.tpcwire.com

Trans Canada Wire & Cable Co.
(888) 926-9473
www.transcanadawireandcable.com

Trench Grader
(870) 697-2226
www.trenchgrader.com

WECS Electric Supply, Inc.
(760) 251-0040
www.wecselectric.net

Wesco Distribution, Inc.
(817) 831-4526
www.wesco.com



INTERNATIONAL
SPECIALIZED TRAILER MFG., LLC



*IST is a
Trailer Manufacture
for the wind energy and
heavy haul transportation
industry.*



*We manufacture top
of the line,
quality designed
trailers.
See our selection of
Blade Trailers,
Schnabls, Dollies,
Jeeps, and Multi axles
units for sale on our
website.*



*IST
The Lead to
Follow!*



Call for pricing.





Contact Us
www.isttrailer.com
1-866-253-3144
infoist@hutchtel.net



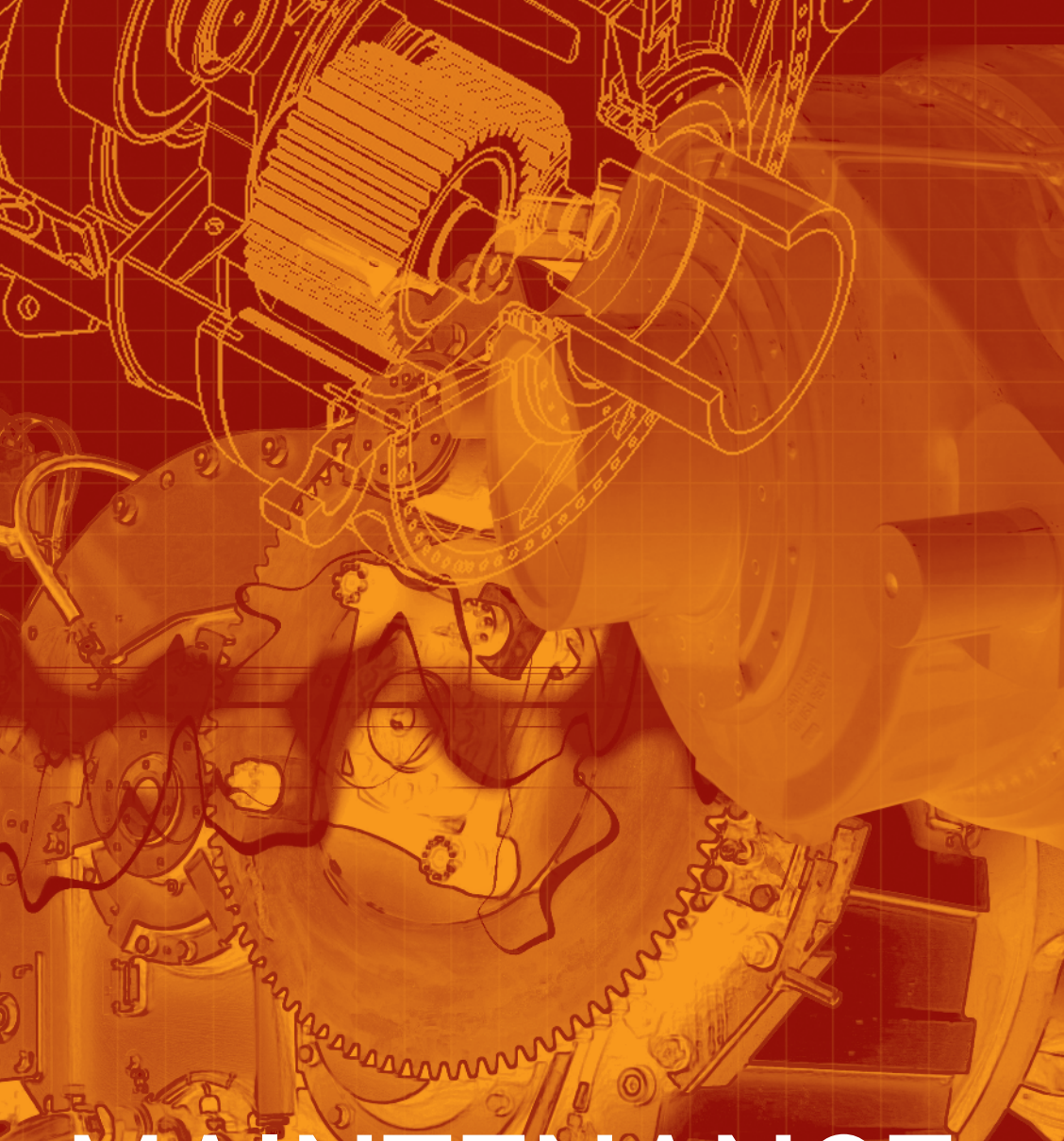

MAINTENANCE

Alignment Equipment.....	37	Lighting	39
Blade Services.....	37	Lightning/Surge Protection	39
Condition Monitoring Equipment.....	37	Lubricants/Filters/Filtration Systems	40
Condition Monitoring/Analysis	37	Operations/Maintenance	40
Gearbox Repair	38	Pressure Washing.....	45
Generator Repair.....	38	Safety/Rescue Equipment.....	45
Inspection Equipment.....	38	Slings/Lifts.....	45
In-Tower Lifts	38		

ALIGNMENT EQUIPMENT

LUDECA, Inc.
(305) 591-8935
www.ludeca.com

Schaeffler Group U.S.A.
(800) 243-2532
www.fag.com

Seiffert Industrial, Inc.
(972) 671-9465
www.seiffertindustrial.com

Tech Safety Lines
(214) 987-4680
www.techsafetylines.com

Torcup Industrial Bolting Tools
(610) 250-5800
www.torcup.com

VibrAlign, Inc.
(800) 394-3279
www.vibralign.com

BLADE SERVICES

Bronto Skylift
358 (0)20 7927 111
www.bronto.fi

HEATCON, Inc.
(206) 575-0815
www.heatcon.com

ITW Plexus
(800) 851-6692
www.itwplexus.com

Knight & Carver Wind Group
(619) 778-7213
www.kcwind.com

M4 Wind Services, Inc.
(562) 981-7797
www.m4windservices.com

Miles Fiberglass & Composites
(503) 775-7755
www.milesfiberglass.com

Polytech Services Company
(703) 257-1500
www.polytechservicescorp.com

Rope Partner
(831) 460-9448
www.ropepartner.com

Run Energy
(325) 795-1550
www.runenergy.com

Sky Climber Wind Solutions
(800) 255-4629
www.skyclimber.com

Thermion, Inc.
(877) 884-3428
www.thermioninc.com

Wind Energy Services Co.
(877) 349-2423
www.usawindenergyservices.com

Wind Services Group
(281) 554-3456
www.windsvc.com

CONDITION MONITORING EQUIPMENT

AeroBalancer-Rotor Balancing Tools & Service
www.aerobalancer.de

Baumer, Ltd.
(860) 621-2121
www.baumerelectric.com

Flash Technology
(615) 503-2000
www.flashtechology.com

GasTOPS, Ltd.
(613) 744-3530
www.gastops.com

Geo-Instruments
(800) 477-2506
www.geo-instruments.com

Gram & Juhl A/S
45 70202169
www.gramjuhl.dk

Heartland Solutions, Inc.
(800) 957-3493
www.heartlandsolutionsinc.com

Hotset Corporation
(269) 964-0271
www.hotset.com

IFM Efector
(800) 441-8246
www.ifm.com

IFOS
(408) 565-9000
www.ifos.com

InView Energy, Inc.
(630) 299-4994
www.inviewenergy.com

LMS North America
(248) 952-5664
www.lmsintl.com

LUDECA, Inc.
(305) 591-8935
www.ludeca.com

MGM Controls LLC
(325) 583-2831
www.mgmcontrols.com

National Instruments
(512) 683-0100
www.ni.com

SenGenuity
(603) 578-4066
www.sengenuity.com

Schaeffler Group U.S.A.
(800) 243-2532
www.fag.com

The Switch Control & Converters
(603) 886-9010
www.theswitch.com

Turningpoint
(530) 677-9785
www.turningpointwind.com

US Sensor Systems, Inc.
(818) 428-1457
www.ussensorsystems.com

CONDITION MONITORING/ ANALYSIS

Azima DLI
(206) 842-7656
www.azimadli.com

C.C. Jensen, Inc.
(770) 692-6001
www.cjc.dk

ComRent International LLC
(410) 257-3000
www.comrent.net

ESRG
(757) 965-5963
www.esrgtech.com

Flash Technology
(615) 503-2000
www.flashtechology.com

Invernergy
(312) 506-1474
www.invernergylc.com

M4 Wind Services, Inc.
(562) 981-7797
www.m4windservices.com

Ofil, Ltd.
(888) 950-5557
www.ofilsystems.com

SCADA Solutions, Inc.
(760) 720-1115
www.scadasolutions.com

Schenck Trebel Corp.
(631) 242-4010
www.schenck-usa.com

Spin Trends LLC
(509) 394-2663
www.spintrends.com

Stork Materials Technology
(888) STORK55
www.storksmt.com

Swantech
(954) 332-6710
swantech.cwfc.com

Turningpoint
(530) 677-9785
www.turningpointwind.com

Vertical Access
(607) 257-4049
www.vertical-access.com

TRICO TCWIND, Inc.
(888) 694-6200
www.tricotcwind.com

GEARBOX REPAIR

BAMCOR
(216) 265-1100
www.bamcor.cc

Clyde Industrial LLC
(440) 653-1062
www.clydeindustrial.com

COT-PURITECH Wind LLC
(330) 478-6996
www.cot-puritech.com

Field System Machining, Inc.
(847) 468-1313
www.fieldsystems.com

Flatliners Wind Service
(903) 852-6163
www.flatlinerswindservice.com

Hansen Transmissions International
32 11349700
www.hansentransmissions.com

Hisco, Inc.
(713) 934-1631
www.hiscoinc.com

Inpro/Seal
(309) 787-4971
www.inpro-seal.com

IQ Wind Energy LLC
(305) 592-4404
www.iq-wind.com

Magnetech Industrial Services
(800) 837-1614
www.magnetech.com

Malloy Electric
(605) 336-3693
www.malloyelectric.com

Milburn Engineering, Inc.
(206) 365-2818
www.milburnengineering.com

Moventas
(503) 205-7930
www.moventas.com

Pamco Machine Works, Inc.
(626) 358-8288 ext. 12
www.pamcomachine.com

PBS Engineering
(714) 534-6700
www.pbseng.com

Praxair Surface Technologies, Inc.
(317) 240-2329
www.praxair.com

Robeck Fluid Power Co.
(330) 562-1140
www.robeckfluidpower.com

Spin Trends LLC
(509) 394-2663
www.spintrends.com

Sun Steel Treating, Inc.
(877) 471-0840
www.sunsteeltreating.com

3-D Service
(800) 837-1614
www.3-dservice.com

TRICO TCWIND, Inc.
(888) 694-6200
www.tricotcwind.com

Turningpoint
(530) 677-9785
www.turningpointwind.com

Wilson Machine Co., Ltd.
(514) 365-4101
www.wilsonmachine.com

Woodworth, Inc.
(586) 634-8682
www.woodworthheattreating.com

GENERATOR REPAIR

APM Specialty Services
(630) 321-9520
www.apmspecialtyservices.com

BAMCOR
(216) 265-1100
www.bamcor.cc

Delom Group
(514) 642-8220
www.groupeedelom.ca

Electric Motor Service Limited
(780) 496-9300
www.emsl.ca

EMS
(602) 258-8545
www.ems.com

Evans Enterprises Wind Energy
(405) 631-1344
www.goevens.com

Flatliners Wind Service
(903) 852-6163
www.flatlinerswindservice.com

K&N
(509) 838-8000
www.knelectric.com

Magnetech Industrial Services
(800) 837-1614
www.magnetech.com

Power Equipment Maintenance, Inc.
(864) 622-2129
www.peminc.net

Shermco Industries
(888) 743-7626
www.shermco.com

Sloan Electric
(619) 239-5174
www.sloanelectric.com

3-D Service
(800) 837-1614
www.3-dservice.com

TRICO TCWIND, Inc.
(888) 694-6200
www.tricotcwind.com

INSPECTION EQUIPMENT

Bronto Skylift
(352) 895-1109
www.bronto.fi

FORCE Technology
45 43267000
www.forcetechnology.com

GE Sensing & Inspection Technologies
(888) 332-3848
www.geinspectiontechnologies.com

IN-TOWER LIFTS

AVANTI Wind Systems, Inc.
(262) 641-9101
www.avanti-online.com

Columbus McKinnon
(716) 689-5400
www.cmworks.com

Goracon Windpower Access Systems LP
(770) 493-5535
www.goracon.de

Tech Safety Lines
(214) 987-4680
www.techsafetylines.com

Tower Logistics
(304) 525-4116
www.tower-logistics.com

Wind Turbine Personnel Hoist
(866) 943-5438
www.windturbinepersonnelhoist.com

Ripley Lighting Controls
(803) 939-4700
www.ripleylightingcontrols.com

East Coast Lightning Equipment, Inc.
(888) 680-9462
www.eclc.biz

LIGHTING

Dialight Corp.
(732) 919-3119
www.dialight.com

Technostrobe
(877) 578-7623
www.technostrobe.com

Erico Wind Products
(440) 542-3890
www.erico.com

Farlight LLC
(310) 830-0181
www.farlight.com

TWR Lighting, Inc. Orga Aviation
(713) 973-6905 ext. 116
www.twrlighting.com

Harger Lightning & Grounding
(800) 842-7437
www.harger.com

Flash Technology
(615) 503-2000
www.flashtechnology.com

Unimar, Inc.
(315) 699-4400
www.unimar.com

LEA International
(813) 890-3300
www.leainternational.com

Genesis Lamp Corporation
(800) 685-5267
www.genesislamp.com

LIGHTNING/SURGE PROTECTION

Lubbock Electric Company, Inc.
(806) 744-2336
www.lubbockelectric.com

Honeywell International
(480) 619-0797
www51.honeywell.com

Advanced Protection Technologies
(800) 237-4567
www.apttvss.com

Lyncole XIT Grounding
(800) 962-2610
www.lyncole.com

OCAS, Inc.
(703) 752-6212
www.ocasinc.com

Dehn, Inc.
(949) 376-4960
www.dehn-usa.com

MVC-Maxivolt
(806) 371-0722
www.maxivolt.com

Pepperl+Fuchs, Inc.
(330) 425-3555
www.pepperl-fuchs.us

PROTECT WIND TURBINES FROM DAMAGING ELECTRICAL SURGES



Advanced Protection Technologies (APT) carries a full line of hard-wired and DIN Rail mounted SPD's (Surge Protective Devices) to protect the Inverters and other key Turbine system components.

Points for Consideration:

- APT's Hard-wired SPD's – used at the inverter/transformer level
 - UL 1449 Third Edition Listed
 - Full range of voltages and surge capacities to cover all your SPD needs
- APT's DIN Rail SPD's – used for specific applications within the turbine
 - Small Form Factor, no breaker required, cost effective and UL 1449 Third Edition Recognized
- APT's team of engineers are available to assess and give input on all situations
- Immediate and direct factory access

"Professionals Serving Professionals"

Please visit our website WWW.APPTVSS.COM for additional information or email us at ocmsales@apttvss.com



ADVANCED PROTECTION TECHNOLOGIES
14550 58TH ST. N. CLEARWATER, FL 33760
PHONE 800.237.4567 / FAX 727.539.8955

IS YOUR WIND FARM PROTECTED?



Since 1984, East Coast Lightning Equipment, Inc. (ECL) has been a leading supplier of high-quality, UL-listed lightning protection equipment.

LIGHTNING FACTS

5,000,000,000

Annual property losses due to lightning exceed \$5 billion in the U.S.

3 – 5%

Between 3 – 5% of all commercial insurance claims are lightning related

20,000,000

Lightning strikes 20 million times each year in the U.S.

ECL's network of UL-listed, trained lightning protection specialists can assist with all phases of lightning protection system design and installation.



Get grounded.
ECL EAST COAST LIGHTNING EQUIPMENT

MAIL 24 Lanson Drive Winsted, CT 06098
TEL 888-680-9462 **FAX** 860-379-2046
EM info@eclc.biz **WEB** www.eclc.biz

Raycap, Inc.
(509) 892-3660
www.raycap.com

**LUBRICANTS/FILTERS/
FILTRATION SYSTEMS**

Air Sentry Breathers
(800) 699-6318
www.airsentrybreathers.com

AMSOIL Synthetic Lubricants
(931) 801-9401
www.lube-direct.com

Castrol Industrial
(877) 641-1600
www.castrol.com

C.C. Jensen, Inc.
(770) 692-6001
www.cjc.dk

Donaldson Company, Inc.
(800) 846-1846
www.donaldson.com

Egan Oil
(763) 421-0410
www.eganoil.com

Fuchs Lubritech
(913) 422-4022
www.fuchs.com

Herguth Laboratories
800-OIL-LABS
www.herguth.com

Hydraulic Supply & Service Co.
(210) 654-6475
www.hydraulicsupply.com

Hydrotex
(972) 389-8500
www.hydrotexlube.com

Hy-Pro Filtration
(317) 849-3535
www.filterelement.com

Kaydon Filtration
(706) 884-3041
www.kaydonfiltration.com

Klüber Lubrication
(800) 447-2238
www.klubersolutions.com

Lincoln
(314) 679-4286
www.lincolnindustrial.com

MEMOLUB PLI LLC
(800) 635-8170
www.memolub.com

One Eye Industries, Inc.
(403) 242-4221
www.oneeyeindustries.com

Pall Corp.
(516) 484-5400
www.pall.com

Petro-Canada Lubricants
(905) 804-3600
www.lubricants.petro-canada.ca

Sage Oil Vac
(877) 645-8227
www.sageoilvacwind.com

SunSource
(630) 317-2714
www.sun-source.com

Syn-Tech, Ltd.
(630) 620-7050
www.syn-techlube.com

Varelube Systems, Inc.
(949) 735-6710
www.varelubesystems.com

Wilson Co.
(817) 595-2244
www.wilson-company.com

OPERATIONS/MAINTENANCE

Alignment Supplies, Inc.
(419) 887-5890
www.alignmentsupplies.com

Laser Alignment and Condition Monitoring extend Wind Turbine Mean Time Between Repair

**Shaft Alignment
Flatness Measurement**

**Vibration Analysis & Balancing
Online Condition Monitoring**

LUDECA (305) 591-8935 • www.ludeca.com

The advertisement features a background of wind turbines in a green field under a blue sky. Overlaid on this are several technical and operational images: a close-up of a turbine's internal shaft alignment mechanism with a laser sensor; a 3D diagram of a turbine's internal structure showing shaft alignment; a computer monitor displaying a software interface for condition monitoring; a person working at a computer workstation; and a physical control unit or sensor box. The text is prominently displayed in yellow and orange, with the company name and contact information at the bottom left.

WIND TURBINE

GEARBOX ANALYSIS PROGRAM

Maintaining your turbines at peak efficiency!

Provides in depth analysis of wind turbine gearboxes Lubricant and Gearbox Condition Analysis includes:

- Wear Rates
- Wear Particles Analysis
- Particle Counting
- Contamination Levels
- Oil Degradation
- Antioxidant Levels

**Grease Analysis, Filter Analysis
and Oil Quality Studies
along with Internet Data
Management System**



Why would you need to use any other lab?

Call us today to find out how we can assist you in maintaining your turbines!



Herguth Laboratories, Inc.

800-OIL-LABS | herguth.com

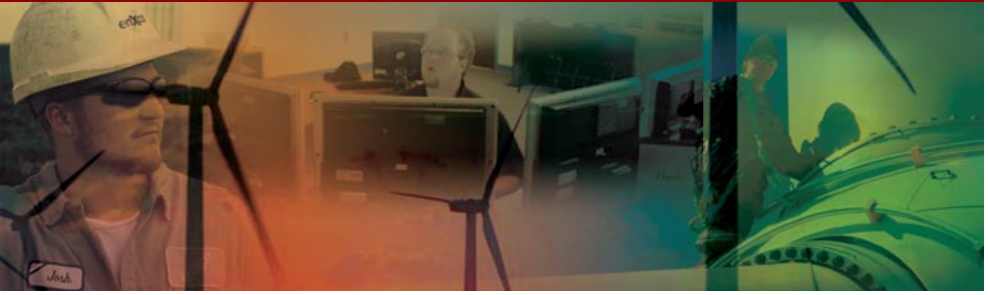

Even as it keeps an eye on its customer's assets, this company conducts quality-control assessments of its own operations, providing additional confidence in its abilities.

IN THE EARLY DAYS OF THE NORTH-AMERICAN wind industry, California's Altamont Pass was a hotbed of wind-farm development. As the towers were erected, and then began to age and fail, turbine maintenance emerged as a promising growth market. Jørn Larsen was one of the first to recognize that opportunity and capitalize on its potential.

"There was basically no thought given to O&M back then, but once these early turbines began to break down Jørn and his partners started refurbishing them for the owners," according to David Luck, director of business development at enXco Service Corp. "And that's how the company got its start."

Widely recognized as a forerunner to this increasingly critical sector of the wind industry—especially as the market matures, and older turbines require upkeep to extend service life—enXco Service Corp. is now part of the EDF Energies Nouvelles family of companies, with sister entities devoted to greenfield development and asset management. Despite their shared provenance, however, they are completely separate companies.

As for the services offered by enXco Service Corp., they are vast, both in terms of range as well as reach. "We provide the full scale of O&M services," Luck says, "and we're involved in a significant portion of the wind-farm projects currently operating in the United States, with others located in Canada."

The company's scope of capabilities includes both scheduled and unscheduled maintenance, parts procurement and inventory control, 24-hour remote monitoring and fault reset, and comprehensive reporting. Monitoring activities are conducted at its NERC-compliant operations control center, or OCC, which currently watches

over nearly 3,000 turbines across the country, every hour of the day, every day of the week. This is a healthy portion of the more than 5,200 turbines it has under contract. "We've been told that it's the finest facility of its kind in the country," Luck says, "and we're constantly updating operations with all the latest available technologies."

While it will subcontract certain services such as snow removal and some blade repair—"although we do handle that ourselves in some areas," Luck says—the vast majority of its activities are conducted by dedicated enXco Service employees. "One of the hallmarks of this company is our internal training program, which has equipped more than 300 of our wind technicians with the knowledge and skills they need to provide the level of service our customers have come to expect from us."

Having enjoyed a front-row seat to the development of the U.S. wind industry from the very beginning, enXco Service utilizes that information in ways that provide maximum benefit to its customers. "Our file cabinet of experience is very deep, and we're able to share that knowledge with our customers in helping them compile accurate information when approaching a new project. If someone is responding to an RFP from a utility company, for instance, we can help them develop a very accurate picture of the maintenance costs involved. And we've also found that our involvement in a project can be very helpful when a group of developers is seeking financing, since we definitely have the reputation and weight to back up our claims.

"We're interested in developing long-term relationships," Luck says, "so we're always glad to get involved in the earliest stages of a project, especially if we can help make it a reality."—R.W. ✎

To learn more call (503) 913-6212, e-mail davel@enxco.com, or go to www.enxco.com.

MAINTENANCE

American Electric Technologies, Inc. (AETI)
(412) 478-4792
www.aeti.com

B9 Energy
(303) 938-3766
www.b9energy.com

BioRem-2000
(714) 225-2550
www.dtdistribution.com

CEJN Industrial Corp.
(224) 430-0173
www.cejn.com

Climax Portable Machine Tools
(503) 538-2185
www.cpmt.com

Clyde Industrial LLC
(440) 653-1062
www.clydeindustrial.com

Composotech Structures, Inc.
(519) 440-0455
www.composotech.com

Dr. Shrink, Inc.
(231) 723-2685
www.dr-shrink.com

Dragon Safety Systems
(702) 835-5297
www.dragonsafetysystems.com

Dragon Wind
(432) 332-8426
www.modernusa.com

Energy Maintenance Systems-Broadwind Energy
(605) 272-5398
www.energys.com

Encore Power Services
(281) 312-0123
www.encorepowerservices.com

enXco Service Corp.
(209) 836-1921
www.enxco.com

Eon WindElectric
(902) 482-8687
www.eonwind.com

Fleetmatics
(847) 463-7660
www.fleetmatics.com

Frontier Pro Services
(831) 427-1035
www.frontierpro.com

Gemini Energy Services
(858) 337-1900
www.geminienergyservices.com

O&M Service?

We come out on top every time.

When the warranty on your turbines is up, there is only one name at the top of O&M services—**enXco Service Corporation**.

With 22 years of experience, enXco can optimize your project availability. We are the industry leader with proven qualifications and resources to do the job right.

enxco...The Trusted Leader in O&M Services

- 5,202 turbines under contract
- In-house training
- Service on-site and on-demand
- Safety & quality control
- 24/7 remote monitoring
- Multiple service shops
- 300+ wind turbine technicians

Dave Luck
Director,
Business Development
503.913.6212
DaveL@enXco.com

enXco
An EDF EN Company

www.enXco.com

Global Energy Services
(610) 940-6088
www.services-ges.com

High Voltage, Inc.
(518) 329-3275
www.hvinc.com

IES Industrial, Inc.
(281) 716-4068
www.ies-co.com

Ingeteam
(262) 240-9850
www.ingeteam.com

Invenergy
(312) 506-1474
www.invenergyllc.com

ITL GmbH
(514) 554-4830
www.itlogistics.net

JLS Enterprises, Inc.
(818) 991-2738
www.jlsenterprisesinc.com

Longo
(973) 537-0400
www.elongo.com

Magnetech Industrial Services
(800) 837-1614
www.magnetech.com

Mariah Resources, Inc.
(800) 619-0845
www.mariahresources.com

Midwest Industrial Supply, Inc.
(330) 456-3121
www.midwestind.com

Minimax U.S.A.
(925) 583-1355
www.mxfire.com

MobileCal
(866) 384-3010
www.mobilecal.net

NAES Corp.
(425) 961-4700
www.naes.com

ORTECH Power
(905) 822-4120 ext. 499
www.ortech.ca

OSM, Inc.
(508) 823-1117
www.osm-inc.com

Outland Renewable Energy LLC
(507) 223-5000
www.outlandenergy.com

PowerWorks LLC
(925) 631-9511
www.powerworks.com

Price Engineering/Price On-Site
(262) 369-3700
www.priceeng.com

R&M Materials Handling, Inc.
(800) 955-9967
www.rmhoist.com

RBG U.S.A., Inc.
(281) 279-1000
www.rbg ltd.com

Reunion Power LLC
(802) 362-9147
www.reunionpower.com

Rev1 Wind
(813) 657-2404
www.rev1wind.com

Run Energy
(325) 795-1550
www.runenergy.com

OILMISER™
Technology
by JLM Systems Limited

OILMISER™
Vapor Guard



- *No Moving Parts,
No maintenance,
Works 24 / 7 / 365*
- *Keeps Lubricating Oil
On the Inside,
Not on the Outside*
- *Extends the Life and
The Efficiency of
Gearbox Air Breathers*
- *Cleaner Air means A Cleaner Nacelle*

For more information visit our website
www.oilmiser.com
Telephone Toll Free: 1-888-736-8645
E-mail: engineering@oilmiser.com

Does Your
Turbine
Maintenance
Look Like This?



Rev1 Wind

1 866 REV1NOW • rev1wind.com
Wind Turbine Inspection,
Operations, and Maintenance

Sky Climber Wind Solutions
(800) 255-4629
www.skyclimber.com

SSB Services, Inc.
(515) 986-9101
www.ssb-group.com

Team Industrial Services
(281) 331-6154
www.teamindustrialservices.com

ThyssenKrupp Safway, Inc.
(770) 323-8481
www.safway.com

Turn Energy Maintenance LLC
(512) 457-0374
www.tem-llc.com

Turningpoint
(530) 677-9785
www.turningpointwind.com

Vaisala, Inc.
(520) 806-7300
www.vaisala.com

Volkswind U.S.A., Inc.
(503) 560-9379
www.volkswind.com

Wazee Wind
(303) 623-8658
www.wazeewind.com

Wind Prospect, Inc.
(720) 542-9922
www.windprospect.com

Ziegler Industries
(800) 422-5278
www.ziegler-industries.com

PRESSURE WASHING

Big Mac's Custom Pressure Wash
(989) 550-2197
www.bigmacwind.com

SAFETY/RESCUE EQUIPMENT

Abatix Corp.
(800) 426-3983
www.abatix.com

Airgas Safety
(800) 827-2338 ext. 14029
www.airgas.com

AVANTI Wind Systems, Inc.
(262) 641-9101
www.avanti-online.com

Capital Safety
(800) 328-6146
www.capitalsafety.com

Dakota Riggers & Tool Supply, Inc.
(800) 888-1612
www.dakotariggers.com

DEUS Rescue
(866) 405-3461
www.deusrescue.com

D2000 Safety, Inc.
(541) 284-2000
www.d2000safety.com

Electromark
(315) 594-8085
www.electromark.com

Elk River, Inc.
(256) 739-5959
www.elkriver.com

Firetrace International
(480) 607-1218
www.firetrace.com

Grainger
(800) 323-0620
www.grainger.com

Hailo LLC
(631) 868-3800
www.hailo.us

IBT, Inc
(800) 332-2114
www.ibtinc.com

Latchways PLC
44 1380732700
www.latchways.com

Midwest Unlimited
(402) 434-5446
www.midwestunlimited.com

Miller Fall Protection/Sperian
(814) 432-2118
www.millerfallprotection.com

Minimax U.S.A.
(925) 583-1355
www.mxfire.com

MSA
(724) 776-8721
www.msanet.com

Petzl
(801) 926-1500
www.petzl.com

Power Climber Wind
(800) 560-2546
www.powerclimberwind.com

PowerQuick, Inc.
(775) 882-8100
www.powerquickinc.com

Pro-Bel Enterprises
(905) 427-0616
www.pro-bel.ca

Rescue Technology
(770) 832-9694
www.rescuetechn1.com

SKYLOTEC GmbH
49 2631 96 80 0
www.skylotec.com

Sperian Protection, Inc.
(800) 343-3411
www.sperianprotection.com

Sterling Rope Co.
(207) 282-2550
www.sterlingrope.com

Tech Products, Inc.
(800) 221-1311
www.techproducts.com

Tech Safety Lines
(214) 987-4680
www.techsafetylines.com

TES, Inc.
(800) 327-4036
www.towergear.com

Tractel, Inc.
(800) 675-6727
www.tractelwind.com

TUF-TUG Products
(937) 299-1213
www.tuf-tug.com

William Frick & Co.
(866) 669-7590
www.fricknet.com

SLINGS/LIFTS

Bronto Skylift
(352) 895-1109
www.bronto.fi

Engineered Lifting Technology
(716) 667-6833
www.eltlift.com

Hanes Supply, Inc.
(716) 826-2636
www.hanessupply.com

Lift-It Manufacturing Co., Inc.
(323) 582-6076
www.lift-it.com

RUD-Chain, Inc.
(319) 294-0001
www.rudchain.com

Tecnomagnete, Inc.
(800) 809-9228
www.tecnomagnete.com

TorqHoist, Inc.
(216) 292-5585
www.torqhoist.com

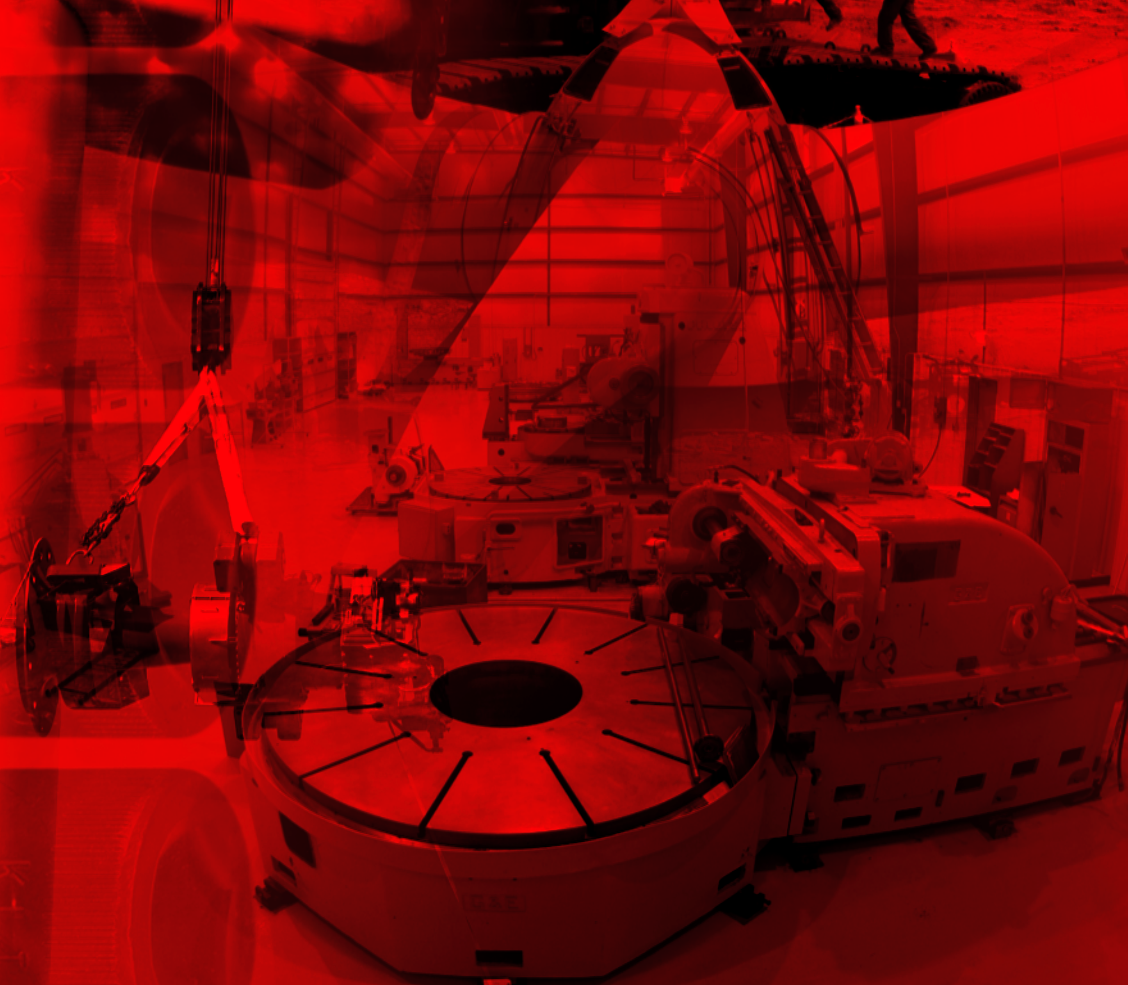

MANUFACTURING

Blades.....	47	Material Handling.....	56
Braking Systems.....	47	Metal Fabrication Equipment.....	58
Coatings/Chemicals.....	47	Metrology.....	59
Composite Manufacturing Equipment.....	47	Other Composite Components.....	59
Composite Materials.....	47	Other Turbine Components.....	59
Contract Machining.....	48	Pitch/Drive Systems.....	61
Cutting Tools.....	51	Slip Rings/Brushes.....	61
Design Services/Equipment.....	51	Steels/Metals.....	61
Drivetrain Systems.....	52	Turbine Systems.....	62
Gears/Bearings.....	52	Tower Internals.....	63
Gear Manufacturing Equipment.....	54	Turbine Subcomponents, Electrical.....	63
Generators.....	55	Turbine Subcomponents, Mechanical.....	65
Hubs/Rings/Forged Components.....	55	Turbine Towers.....	65
Machining Centers/Machine Tools.....	56	Workholding.....	65

BLADES

Fibergrate Composite Structures

(800) 527-4043
www.fibergrate.com

PCM Molds and Patterns

(418) 883-4009
www.pcmolds.com

Solent Composite Systems, Ltd.

441983292602
www.solentcomposites.com

TPI Composites, Inc.

(480) 305-8910
www.tpicomposites.com

Wind Energy Services Co.

(877) 349-2423
www.usawindenergyservices.com

BRAKING SYSTEMS

A&A Manufacturing

(800) 298-2066
www.gortite.com

Alco Brakes, Inc.

(418) 640-0007
www.alcobrakes.com

Carlisle Brake And Friction

(812) 336-3811
www.windbrake.us

Friction Systems

(877) 437-4832
www.frictionsystems.com

Kobelt Manufacturing Company, Ltd.

(604) 572-3935
www.kobelt.com

Scan-Pac Mfg., Inc.

(262) 250-2303
www.scanpac.com

SIPCO

(281) 480-8711
www.sipco-mls.com

Svendborg Brakes Deutschland

49 5223854011
www.svendborg-brakes.com

The Rowland Co.

(215) 455-4900
www.rowland2.com

Tribco, Inc.

(216) 486-2000
www.tribco.com

W.C. Branham, Inc.

(715) 426-2000
www.wcbranham.com

COATINGS/CHEMICALS

American Polywater Corp.

(651) 430-2270
www.polywater.com

BASF Corporation

(248) 948-2253
www2.basf.us

Bergolin U.S.A.

(336) 722-5580
www.bergolinusa.com

Daubert Cromwell

(800) 535-3535
www.daubertcromwell.com

DSI Ventures, Inc.

(903) 526-7577
www.dsiventures.com

ITW Futura Coatings

(314) 733-1110
www.futuracoatings.com

Polytech Services Company

(703) 257-1500
www.polytechservicescorp.com

PRO-SET, Inc.

(888) 377-6738
www.prosetepoxy.com

Shell Valley Cos., Inc.

(402) 246-2355
www.shellvalley.com

Thermion, Inc.

(877) 884-3428
www.thermioninc.com

Tristar Coatings, Ltd.

(800) 975-5568
www.tristarcoatings.com

**COMPOSITE
MANUFACTURING
EQUIPMENT**

C.R. Onsrud, Inc.

(704) 528-4528
www.cronsrud.com

Carter Products Company, Inc.

(888) 622-7837
www.carterproducts.com

CITEL

(954) 430-6310
www.citel.us

Dynabrade, Inc.

(716) 631-0100
www.dynabrade.com

Exact Dispensing Systems

(207) 563-2299
www.exactdispensing.com

Frees, Inc.

(800) 978-3733
www.freesinc.com

Gerber Technology

(860) 871-8082
www.gerbertechnology.com

Global Finishing Systems

(262) 253-8720
www.globalfinishing.com

Graco, Inc.

(877) 844-7226
www.graco.com

GS Manufacturing International

(949) 642-1500
www.gsmfg.com

Ingersoll Machine Tools, Inc.

(815) 987-6114
www.ingersoll.com

KMT Robotic Solutions

(248) 829-2800
www.kmtgroup.com

Lectra

(770) 422-8050
www.lectra.com

M.V.P. Magnum Venus Plastech

(727) 573-2955
www.mvpind.com

MAG

(859) 534-4600
www.mag-ias.com

McClelland Anderson

(715) 355-3006
www.mcclellandanderson.com

Precision Quincy Corp.

(815) 338-2675
www.precisionquincy.com

The Grieve Corporation

(847) 546-8225
www.grievecorp.com

Visioneering, Inc.

(586) 293-1000
www.vistool.com

Wisconsin Oven Corp.

(262) 642-3938
www.wisoven.com

COMPOSITE MATERIALS

Alliance LLC

(219) 548-3799
www.allianceorg.com

Ashland Distribution

(800) 531-7106
www.ashland.com

Carter Products Company, Inc.

(888) 622-7837
www.carterproducts.com

Cetek Technologies, Inc.

(845) 452-3510
www.cetektechnologies.com

Columbia Industrial Products

(541) 607-3655
www.cipcomposites.com

Composites One LLC

(800) 621-8003
www.compositesone.com

Creative Foam Composite Systems

(810) 629-4149
www.creativefoam.com

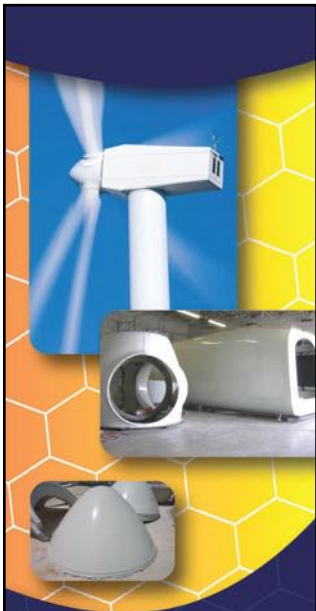

Our Power — Strengthening Your Power

Committed to fostering renewable energy, McClarin Plastics, Inc. produces components for wind turbines and, provides a suite of services.

- Vacuum infusion and Resin Transfer molding
- Design support
- Full-service Contract Manufacturer
- Six Sigma, Black Belt quality team
- Incorporates Kaizen and multiple Lean principles

McClarin Plastics, Inc.
SOLUTIONS IN PLASTICS

15 Industrial Drive, P.O. Box 486
Hanover, PA 17331
(717) 637-2241



(800) 233-3189

Email: mcclarin@mcclarinplastics.com

www.mcclarinplastics.com/wind

DIS-TRAN Wood Products
(318) 448-0274
www.distran.com

Fenner Precision
(717) 664-8269
www.fennerprecision.com

GEOTEK, Inc.
(507) 533-6076
www.geotekinc.com

Global Diversified Sales
(215) 478-2586
www.globaldiversifiedsales.com

Gurit
(819) 847-1863
www.gurit.com

Hadlock Plastics LLC
(440) 466-4876
www.hadlockplastics.com

Hexion Specialty Chemical
(310) 884-5538
www.hexion.com

Huntsman Corp.
(281) 719-7487
www.huntsman.com

JAMAK Fabrication, Inc.
(817) 598-5217
www.jamak.com

JSP
(724) 477-5100
www.jsp.com

Knowlton Technologies LLC
(315) 782-0600
www.knowlton-co.com

McClarin Plastics, Inc.
(717) 637-2241
www.mcclarinplastics.com

M4 Engineering
(562) 981-7797
www.m4-engineering.com

MID American Supply Corp.
(316) 683-5959
www.mid-composite.com

Molded Fiber Glass Companies
(440) 994-5222
www.moldedfiberglass.com

Nordic Fiberglass, Inc.
(218) 745-5095
www.nordicfiberglass.com

Northern Fiber Glass Sales, Inc.
(603) 926-1910
www.nfgsales.com

Norton
(508) 795-2183
www.nortonabrasives.com

Polynova Composites
(508) 888-0462
www.polynovacomposites.com

PPG Industries, Inc.
(412) 820-2860
corporateportal.ppg.com

Saertex U.S.A. LLC
(704) 464-5998
www.saertex.com

Schunk Graphite Technology
(262) 253-8720
www.schunkgraphite.com

The Gund Co. Canada LLC
(519) 843-4660
www.thegundcompany.ca

3M
(888) 364-3577
www.3m.com

Toho Tenax America, Inc.
(800) 252-3001
www.tohotenaxamerica.com

Trelleborg Sealing Solutions
(260) 749-9631
www.tss.trelleborg.com

Vectorply Corp.
(334) 291-7704
www.vectorply.com

WCI Wind Turbine Components LLC
(715) 856-6321 ext. 230
www.wauscomp.com

WebCore Technologies LLC
(937) 435-2200
www.webcoreonline.com

Wind Energy Services Co.
(877) 349-2423
www.usawindenergyservices.com

Zoltek Corp.
(314) 291-5110
www.zoltek.com

CONTRACT MACHINING

A.J. Rose Manufacturing Company
(440) 934-2859
www.ajrose.com

Aluminum Fabricators, Inc.
(816) 231-8888
www.aluminumfabricatorskc.com

Anchor Fabrication
(817) 232-4575
www.anchorfabrication.com

Astro Machine Works, Inc.
(717) 738-4281
www.astromachineworks.com

Atcam, Inc.
(920) 766-7880
www.atcam.org

Barnes Manufacturing Services
(319) 377-3442
www.barnesmfg.com



BUILDING BIG THINGS FOR TOMORROW

BEGINS WITH MAKING THE RIGHT CHOICE TODAY

With expected increases of wind power generated electricity, many manufacturers will be faced with new challenges when producing components such as gear boxes, casings and shafts.

With premium tooling and process technology, Seco is ready to provide solutions for the Wind Power Industry, from residential size up to utility scale.

Included are the latest advancements

in cutting tool technology like Duratomic™ turning and milling grades, Jetstream Tooling™ and Square 6™ milling cutters.

Ask about our strategies for machine tools, cutting tools, processes and analysis for improved cost savings and control. Contact a Seco Solutions expert today, by visiting www.secotools.com/us/windgeneration.



SECO 

www.secotools.com/us/windgeneration

MILLING • TURNING • HOLEMAKING • THREADING • TOOLING SYSTEMS

Bedford Machine and Tool, Inc.
(800) 264-1948
www.bedfordmachine.com

C&C Machine, Inc.
(800) 658-9099
www.ccmach.com

Cast-Fab Technologies
(513) 758-1000
www.cast-fab.com

Cincinnati, Inc.
(513) 367-7663
www.e-ci.com

Diversified Machine Components
(440) 942-5701
www.diversifiedmc.com

EIMCO, Inc.
(563) 927-6266
www.eimcoinc.com

Elektro Assemblies
(800) 533-1558
www.elektroassemblies.com

Excel Gear
(815) 623-3414
www.excelgear.com

Forest City Gear
(866) 623-2168
www.fcgear.com

G.E. Mathis Co.
(773) 586-3800
www.gemathis.com

Gleason Corp.
(585) 473-1000
www.gleason.com

GlenMartin, Inc.
(800) 486-1223
www.glenmartin.com

GMT Corporation
(800) 258-4648
www.gmtcorporation.com

Havlik Gear
(519) 624-6240
www.havlikgear.com

Hibbing Fabricators
(218) 262-5575
www.hibfab.com

HPM America-a Taylor's Company
(419) 946-0222
www.hpamerica.com

Industrial Sales & Manufacturing
(814) 833-9876
www.ismerie.com

Infinite Energy Manufacturing LLC
(877) 901-5111
www.infiniteenergymfg.com

Jaquith Industries
(315) 677-9538
www.rclenterprises.com

John Ramming Co.
(610) 584-3599

Metalade NY, Inc.
(585) 424-3260
www.metalade.com

McClarín Plastics, Inc.
(717) 637-2241
www.mccclarinplastics.com

MG Machine, Inc.
(816) 331-8886
www.mgmachine.com

PH Windsolutions, Inc.
(514) 522-6329
www.phwindsolutions.com

Plessitech
(819) 362-6315
www.plessitech.com

IMPROVE YOUR BOTTOM LINE

with Infusion Flow Reinforcements™

HIFLUX-90™

The HIFLUX-90™ profile separates adjacent lamina providing a bilateral flow path resulting in rapid and thorough wet out.

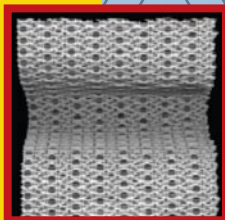

PolyBeam® 703

Collapsed under the influence of vacuum pressure, PolyBeam® provides the mean free path for resin flow.

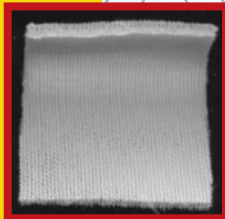

\$10,000
could be yours!

The company that purchases the millionth yard of PolyBeam or HIFLUX 90 for use in Wind Blades

 **POLYNOVA™**
COMPOSITES

6 Nesting Way | P.O. Box 1078
East Sandwich, MA 02537
P. 508-888-0462 | F. 508-888-0984
Dick Mastromatteo | E. richard@cape.com

polynovacomposites.com

Plexus
(920) 722-3451
www.plexus.com

Precise Tool And Manufacturing
(585) 247-0700 ext. 209
www.precisetool.com

Prototech Laser, Inc.
(586) 598-6900
www.ptlaser.com

Raycar Gear
(815) 874-3948
www.raycargear.com

RBA, Inc., Broadwind Energy
(920) 482-3554
www.rbainc.org

Roberts Automatic
(992) 949-1000
www.robertsautomatic.com

Romi Industrias
(262) 446-4485
www.romi.com.br

Spartanburg Stainless Products
(864) 699-3200
www.ssprod.com

Stillwater Technologies, Inc.
(937) 440-2528
www.stlwtr.com

Technical Die-Casting, Inc.
(507) 689-2194
www.tech-die-casting.com

The Woodworth Group
(313) 891-1440
www.woodworthheattreating.com

TNE International LLC
(248) 299-1920
www.tneintl.com

U.S. Axle, Inc.
(610) 323-3800
www.usaxle.com

Utica Enterprises
(586) 726-4300
www.uticaenterprises.com

CUTTING TOOLS

Big Kaiser Precision Tooling, Inc.
(888) 866-5776
www.bigkaiser.com

Emuge Corp.
(800) 323-3013
www.emuge.com

Ingersoll Cutting Tools
(815) 387-6600
www.ingersoll-imc.com

Iscar Metals, Inc.
(817) 258-3200
www.iscarmetals.com

Kennametal
(724) 539-5000
www.kennametal.com

Sandvik Coromant
(201) 794-5000
www.coromant.sandvik.com/us

Seco Tools
(248) 528-5200
www.secotools.com

Valenite
(248) 733-6980
www.valenite.com

Walter U.S.A.
(800) 945-5554
www.walter-tools.com

**DESIGN SERVICES/
EQUIPMENT**

American Superconductor
(978) 842-3000
www.amsc.com

DARcorporation
(785) 832-0434
www.darcorp.com

DNV Global Energy Concepts
(206) 387-4200
www.globalenergyconcepts.com

Greenward Technologies, Inc.
(888) 530-7772
www.greenward-technologies.com

AFFORDABLE PRECISION HAND-HELD GAGES FOR WIND TURBINE GEAR AND SPLINE PRODUCERS!



Call Parker Industries Toll Free at 1-877-567-GAGE for fast friendly service and ask our technical experts to help you with selecting the appropriate hand-held barrel or digital micrometers and combination gages to measure:

- *Wk- gear tooth span (base tangent) over Z (No. of teeth) on external gears, and yes even internals too!*
- *Gear size via Mdk or Dimension Over Pins/Wires/-or- Balls*
- *Calculation software for Wk-span or Mdk/DOP or DUP*
- *Major and Minor Diameter Size and Bore Gaging*
- *Spline Gages, Master Gears, and Inspection Arbors*
- *Contract Inspection Services and More!*



Our **FORM-RITE®** gages are robust by design and precision crafted of only the highest quality components by old world experts in the field of dimensional and gear and spline metrology.

And don't forget to ask why our ball micrometers last two to three times longer than the competition.



PARKER Industries Incorporated
1650 Sycamore Avenue | Bohemia, New York 11716

1-877-567-GAGE • T: 631-567-1000 • F: 631-567-1355 • W: parkerind.com

Intertek
(800) WORLDLAB
www.intertek.com/wind

McClarin Plastics, Inc.
(717) 637-2241
www.mcclarinplastics.com

M4 Engineering
(562) 981-7797
www.m4-engineering.com

Real Gas And Electric Co.
(707) 526-3400
www.realgasandelectric.com

Romax Technology
44 01159518800
www.romaxtech.com

S&C Electric Co.
(773) 338-1000
www.sandc.com

SunWind Power Systems, Inc.
(502) 876-5174
www.sunwindpowerinc.com

Turningpoint
(530) 677-9785
www.turningpointwind.com

DRIVETRAIN SYSTEMS

**Axletech International-
a General Dynamics Co.**
(248) 435-1083
www.axletech.com

CENTA Corp.
(630) 236-3500
www.centa.info

Hansen Transmissions International
32 11349700
www.hansentransmissions.com

IQ Wind Energy LLC
(305) 592-4404
www.iq-wind.com

Semikron, Inc.
(818) 812-6392
www.semikron.com

**The Switch Controls and
Converters**
(603) 886-9010
www.theswitch.com

Voith Turbo Wind GmbH & Co. KG
49 7951 32 1867
www.voithturbo.com

GEARS/BEARINGS

ABX Distributing
(713) 957-1700
www.abxbearings.com

Aerocom Industries
(303) 776-4300
www.aerocom-industries.com

American Roller Bearing Co.
(412) 952-2004
www.amroll.com

**Applied Industrial
Technologies**
(216) 426-4000
www.applied.com

Atlantic Custom Bearings
(305) 592-4404
www.atlantic-bearing.com

Avon Bearings-Kaydon
(440) 871-2500
www.kaydon.com

B&R Machine and Gear
(800) 238-0657
www.brgear.com

Bartlett Bearing Company, Inc.
(800) 523-3382
www.bartlettbearing.com

Belgen, Inc.
(819) 477-2434
www.belgen.net

**Brad Foote Gear Works,
Broadwind Energy**
(708) 298-1100
www.bradfoote.com

Brevini U.S.A.
(281) 450-0070
www.breviniusa.com

Carnes-Miller Gear
(800) 273-6814
www.cmgear.com

**Carolina Gear
& Components**
(519) 623-8806
www.cgc-group.net

Chalmers & Kubeck
(610) 494-4300
www.candk.com

Cinetic Landis
(301) 797-3400
www.fivesgroup.com

Cleveland Gear Co.
(216) 641-9000
www.clevelandgear.com

Cole Mfg. Systems, Inc.
(248) 601-8145
www.colemfgsystems.com

Columbia Gear Corp.
(320) 356-7301
www.columbiagear.com

Consolidated Bearings Co.
(973) 539-8300
www.consbrgs.com

Excel Gear
(815) 623-3414
www.excelgear.com

Federal Gear
(440) 946-4327
www.federalgear.com

Forest City Gear
(866) 623-2168
www.fcgear.com

Glebus Alloys LLC U.S.A.
(330) 867-9999
www.glebusalloys.com

**Hansen Transmissions
International**
32 11349700
www.hansentransmissions.com

Havlik Gear
(519) 624-6240
www.havlikgear.com

Horsburgh & Scott Co.
(216) 431-3900
www.horsburgh-scott.com

**Ideal Gear & Machine
Works, Inc.**
(604) 952-4327
www.idealgearworks.com

IMO Energy GmbH & Co. KG
49 9193639530
www.imo.de

IQ Wind Energy LLC
(305) 592-4404
www.iq-wind.com

ISC Cos.
(605) 336-3471
www.industrialsupplyco.com

**Kaman Industrial
Technologies**
(860) 687-5185
www.kamandirect.com

Kowalski Heat Treating
(216) 631-4411
www.khtheat.com

Li Gear, Inc.
(630) 226-1688
www.ligear.com

**Lubbock Electric
Company, Inc.**
(806) 744-2336
www.lubbockelectric.com

Maguire Technologies
(978) 462-0701

Midpoint Bearing
(800) 227-2136
www.midpointbearing.com

Milwaukee Gear
(414) 962-3532
www.milwaukeegear.com

Motion Industries
(800) 526-9328
www.motionindustries.com

New Way Air Bearings
(610) 364-3453
www.newwayairbearings.com

NTN Bearing Corp.
(847) 298-7500
www.ntnamerica.com

Overton Gear & Tool Corp.
(630) 543-9570
www.overtongear.com

Capture the full potential!



Invite a yellow coat.

The wind power business is growing rapidly leading to new metal cutting challenges. As a Sandvik Coromant partner, you can always rely on a specialist nearby, focused on your success. Smart solutions for every component; from the base of the tower to the blade.

24-hour delivery of premium tools to almost every corner of the world is only one promise. Measurable results on the bottom line is another. Let's optimize your potential together!

Call 1-800-SANDVIK (1-800-726-3845) to talk to a Sandvik Coromant representative near you.

Think smart | Work smart | Earn smart



Your success in focus

Powertrain Technologies
(800) 273-6814
www.powertraintechnologies.com

Raycar Gear
(815) 874-3948
www.raycargear.com

Ritbearing Corp.
(800) 431-1980
www.ritbearing.com

Romax Technology, Inc.
(248) 687-1440
www.romaxtech.com

Rotek, Inc.
(330) 995-7262
www.rotetek-inc.com

R.P. Machine Enterprises, Inc.
(704) 872-8888
www.rpmachine.com

Schaeffler Group U.S.A.
(800) 243-2532
www.fag.com

SIPCO
(281) 480-8711
www.sipco-mls.com

SKF U.S.A., Inc.
(215) 513-4400
www.skf.com

UVLM, Inc.
(360) 736-2333
www.uvlm.com

The Timken Co.
(330) 471-6645
www.timken.com

Vancouver Gear
(877) 888-3111
www.vangear.com

Wittenstein
(888) 534-1222
www.alphagear.com

Zero-Max
(888) 773-8845
www.zero-max.com

GEAR MANUFACTURING EQUIPMENT

Advance Products & Systems
(337) 233-6116
www.apsonline.com

Bourn & Koch
(815) 965-4013
www.bourn-koch.com

Cinetic Landis
(301) 797-3400
www.fivesgroup.com

Drake Manufacturing
(330) 847-7291
www.drakemfg.com

Gleason Corp.
(585) 473-1000
www.gleason.com

**Greenerd Press & Machine
Company**
(800) 877-9110
www.greenerd.com

KAPP Technologies
(303) 447-1130
www.kapp-usa.com

Liebherr
(734) 429-7225
www.liebherr.com

Methods Machine Tools, Inc.
(978) 443-5388
www.methodsmachine.com

**Mitsubishi Heavy
Industries America**
(248) 669-6136
www.mitsubishigearcenter.com

New England Gear
(860) 223-7778
www.newenglandgear.com

**Niles Simmons
Hegenscheidt**
(586) 283-6467
www.niles-simmons.de

R.P. Machine Enterprises, Inc.
(704) 872-8888
www.rpmachine.com

Reishauer
(847) 888-3828
www.reishauer.com



Effective wind energy starts with high part accuracy.

The reliability of wind turbines depends highly on the accuracy of critical parts such as pinion cages and housings of planetary gears. Leading manufacturers around the world rely on Carl Zeiss MMZ CMMs with VAST Active Scanning and CALYPSO software to verify critical components and ensure part quality.

www.zeiss.com/mmz



Carl Zeiss
IMT Corporation
(800) 327-9735
www.zeiss.com/imt



Styli & Accessories
• Same-day Shipping
• ZEISS Components
• Dedicated Service
• M2-M5 In-stock



We make it visible.

Star SU LLC
(847) 649-1450
www.star-su.com

Walinga, Inc.
(204) 745-2951
www.walinga.com

GENERATORS

Baldor Electric Company
(479) 646-4711
www.baldor.com

Clean Energy Technologies, Inc.
(866) 933-4238
www.cleanenergytechnologies.net

Clifford Power Systems, Inc.
(800) 324-0066
www.cliffordpower.com

Danotek Motion Technologies
(734) 426-5976
www.danotekmotion.com

Hitachi America, Ltd.
(914) 524-6629
www.hitachi-america.us

Ingeteam
(262) 240-9850
www.ingeteam.com

Leroy Somer
(314) 553-2443
www.leroysoomer.com

Lubbock Electric Company, Inc.
(806) 744-2336
www.lubbockelectric.com

Magnetek, Inc.
(866) 381-2035
www.alternative-energies.com

Quality Control Corp.
(708) 887-6259
www.qccorp.com

Sicme Motori SpA
39 0114076311
www.sicmemotori.com

The Switch Controls and Converters
(603) 886-9010
www.theswitch.com

HUBS/RINGS/FORGED COMPONENTS

Ajax Rolled Rings
(803) 628-2310
www.ajaxring.com

ATI Casting Service
(219) 362-1000
www.aticastingsservice.com

CAB, Inc.
(678) 745-2100
www.cabinc.com

Canton Drop Forge
(330) 477-4511
www.cantondropforge.com

Castech Metallurgy
(418) 338-3171
www.castechinc.com

Charles E. Larson & Sons, Inc.
(773) 772-9700
www.larsonforge.com

Clifford-Jacobs
(217) 352-5172
www.clifford-jacobs.com

Concast Metals
(724) 538-3956
www.concast.com

Ellwood Group, Inc.
(484) 356-1290
www.elwd.com

Hodge Foundry
(724) 588-4100
www.hodgefoundry.com

JRoe & Associates, Industrial Resources
(519) 560-1413
www.jroeassociates.com

Kocsis Brothers Machine
(708) 597-8110
www.kocsisbros.com

Lufkin Industries, Inc.
(936) 637-5353
www.lufkin.com

McInnes Rolled Rings
(800) 569-1420
www.mcinnesrolledrings.com

Metro Machine Works, Inc.
(734) 941-4571
www.metromachineworks.net

Milko Tool & Die
(402) 345-2923
www.milkoinc.com

Oxford Engineered Materials Corp.
(440) 333-0027
www.machined-castings.com

Sorel Forge Co.
(450) 746-4030
www.sorelforge.com

Stafford Manufacturing Co.
(978) 657-8000
www.staffordmfg.com

Troy Forge Company
(248) 362-8500
www.troyforge.com

Walker Forge
(262) 554-2929
www.walkerforge.com

Willman Industries
(920) 668-8526
www.willmanind.com

MANUFACTURING

EXCEL GEARS... And Much More

Precision gears, high-speed spindles, CNC gimbal heads, wind turbines, even gearbox assemblies for battleship gun turrets.

That's the breadth of design, build and testing capabilities Excel brings to your company for high speed and high power, with smooth and quiet operation. Gear grinding to AGMA 15 (DIN 2) at 60" external diameters, gear hobbing to 70" maximum pitch diameter. Spindles to 80,000 RPM and up to 300 HP. All ANSYS, MILSIM and SPC protocols.

*All with our personalized service and guaranteed performance. You **CAN** have it all! Talk to us for your next project.*



EXCEL GEAR, INC.

A TOTAL SERVICE COMPANY

www.excelgear.com | 815-623-3414

Roscoe, IL 61073

MACHINING CENTERS/ MACHINE TOOLS

DMG America
(630) 227-3932
www.dmgamerica.com

Haas Automation, Inc.
(805) 278-1800
www.haascnc.com

Hardinge
(607) 734-2281
www.hardingeus.com

MAG Industrial Automation
(920) 921-9400
www.giddings.com

Makino Machine Tool
(513) 573-7200
www.makino.com

Mazak Corp.
(859) 727-5700
www.mazakcorp.com

Mori Seiki
(847) 593-5400
www.moriseiki.com

Junker Machinery
(847) 488-0406
www.junker-usa.com

Okuma
(704) 588-7000
www.okuma.com

MATERIAL HANDLING

Airfloat LLC
(217) 423-6001
www.airfloat.com

**Baoding Hoist and
Transportation
Equipment Factory**
86-3123115353
www.bdqz.com.cn

**Conveyor Application
Systems**
(541) 463-9451
www.slingers.com

**Fantuzzi Noell
U.S.A., Inc.**
(202) 686-7672
www.fantuzzinoellusa.com

Gallo Equipment Company
(773) 374-5515
www.galloequipment.com

GENESYS Industrial
(816) 525-7701
www.genesyscorp.net

Hoist Lifteruck Mfg., Inc.
(708) 458-2200
www.hoistlift.com

Konecranes Americas
(800) 934-6976
www.konecranesamericas.com

Magnetic Products, Inc.
(248) 887-5600
www.mpimagnet.com

**MSC Industrial
Supply Co.**
(516) 812-2000
www.mscdirect.com

RUD-Chain, Inc.
(319) 294-0001
www.rudchain.com

Runnion Equipment Co.
(708) 447-3169
www.runnionequipment.com

Shuttlelift
(920) 743-8650
www.shuttlelift.com

**Smock Material
Handling**
(317) 890-3200
www.smockmh.com

Stor-loc
(815) 936-0700
www.storloc.com

**Taylor Machine
Works, Inc.**
(662) 773-3421
www.taylorbigred.com

Walker Magnetics
(800) 853-3232
www.walkermagnet.com



Work Holding Confidence

From large locomotive gears, to 6-F and 6-R automobile transmissions, to turbine blades and today's most advanced military jet fighters, even the space shuttle arm, we have solutions for you. We are Hydra-Lock, and in addition to confidence, you will also see reliability and quality for all of your I.D. and O.D. applications.



From machining to measurement, inspection and metrology, to balance and assembly, Hydra-Lock designs, engineers and manufactures industry's best hydraulic work holding.

**HYDRA-LOCK
CORPORATION**

Originators and developers of Hydraulic Chucking
www.hydralock.com

Vehicle Industries | Gear Industries | Aerospace & Defense | Medical | General Engineering

Our Masters **Take Motion** to an Art Form



In this collection, the certified masters at Overton Chicago Gear elevate the concept of motion to an art form. Examples of their work appear across the globe, forever moving, powering entire communities. But to truly understand the brilliance of the art, you need to look deeper, going past the facade to the inner workings and close-tolerance gearing. There you will find perfection.



OVERTON CHICAGO GEAR
PROCESS-DRIVEN PRECISION

(630) 543-9570 | www.oc-gear.com | info@oc-gear.com
100% Employee Owned

StaClean™

**BLADE
COATING**

**16 YEARS FIELD
EXPERIENCE**

no cracks - no peeling

**EXTENDS
BLADE LIFE**

- Flexible tough moisture seal
- Impact resistant
- Easy applied in field or by factory



**Sheds Ice and Insects
Improves Efficiency**



Polytech Services Corp. LTD

<http://www.polytechservicescorp.com>
e-mail: polytechservices@earthlink.net
12169 BALLSFORD RD. • PHONE (703) 257-1500
MANASSAS, VA 20109 USA

**METAL FABRICATION
EQUIPMENT**

2K Energy Consulting
(361) 648-1301
www.2kenegyconsulting.com

AMC Automation and Modular
(248) 922-4740
www.amcautomation.com

Ameritherm, Inc./Ambrell Co.
(585) 889-9000
www.ameritherm.com

Arrow United Industry
(570) 746-7112
www.arrowunited.com

**Astoria Wire and Metal
Products**
(708) 496-9950
www.astoriawire.com

Blastec, Inc.
(770) 475-2700
www.blastec.com

Cinetic Landis
(301) 797-3400
www.fivesgroup.com

Cole-Tuve, Inc.
(410) 933-0700
www.coletuve.com

COMEQ, Inc.
(410) 933-8500
www.comeq.com

Davi North America
(815) 282-8550
www.davinorthamerica.com

Dawson-Macdonald Co., Inc.
(800) 556-4456
www.dawson-macdonald.com

**Eagle Bending/Carell
Corporation**
(251) 937-0947
www.eaglebendingmachines.com

E.G. Heller's Son, Inc.
(800) 233-0929
www.hellerson.com

**ESAB Welding & Cutting
Systems**
(843) 669-4111
www.esabna.com

Foremost Machinery
(847) 272-7880
www.foremostmachinery.com

Genzink Steel
(616) 494-8427
www.genzinksteel.com

Goff, Inc.
(405) 382-6900
www.goff-inc.com

**Graebener Group
Technologies**
(419) 591-7033
www.graebtec.com

**Greenerd Press & Machine
Company**
(800) 877-9110
www.greenerd.com

Hankook America Corp.
(630) 562-9240
www.hankookamerica.com

Inductoheat, Inc.
(248) 585-9393
www.indusctoheat.com

Industrial Associates
(262) 544-4211
www.industrialassociates.com

Lincoln Electric
(440) 481-8100
www.lincolnelectric.com

**MAG Powertrain North
America**
(586) 532-3069
www.mag-ias.com

Nickleson Machine & Tool, Inc.
(519) 256-7849
www.nicklesontool.com

Northern Iron & Machine
(651) 778-3300
www.northernim.com

Prima North America
(413) 598-5200
www.prima-na.com

Process Equipment Company
(937) 667-4451
www.peco-us.com

PSMi
(734) 677-0454
www.psmicorp.com

Quickmill, Inc.
(705) 745-2961
www.quickmill.com

Strohwig Industries
(262) 628-5444
www.strowig.com

TMS Metalizing Systems, Ltd.
(360) 692-6656
www.tmsmetalizing.com

VAC-U-MAX
(973) 759-4600
www.vac-u-max.com

Velocity Machine, Inc.
(920) 621-3585
www.velocitymachine.com

Walinga, Inc.
(204) 745-2951
www.walinga.com

Waukesha Metal Products
(262) 820-9000
www.waukeshametal.com

Wheelabrator Group
(800) 845-8508
www.wheelabratorgroup.com

METROLOGY

Automated Precision, Inc.
(240) 268-0400
www.apisensor.com

Carl Zeiss IMT Corp.
(800) 327-9735
www.zeiss.com

Gleason Corporation
(585) 473-1000
www.gleason.com

Link Engineering Company
(734) 453-0800
www.linkeng.com

L.S. Starrett Co.
(978) 249-3551
www.starrett.com

MSC Industrial Supply Co.
(516) 812-2000
www.mscdirect.com

Parker Industries
(631) 567-1000
www.parkerind.com

Process Equipment
(800) 998-4191
www.gearinspection.com

Proto Manufacturing
(313) 965-2900
www.protxrd.com

OTHER COMPOSITE COMPONENTS

Able Manufacturing & Assembly
(417) 623-3060
www.ablemfg.com

Amtech Corp.
(509) 877-4109
www.amtechcorp.com

Bayview Edison Industries
(360) 466-4160
www.bayviewedisonindustries.com

BEM CNC
(847) 805-9750
www.bemcnc.com

Cerex Advanced Fabrics, Inc.
(850) 937-3321
www.cerex.com

EM-fiberglas AS
45 75687311
www.em-fiberglas.com

GPI Corp.
(715) 359-6123
www.gpicomposites.com

McClarín Plastics, Inc.
(717) 637-2241
www.mccclarinplastics.com

Wind Energy Services Co.
(877) 349-2423
www.usawindenergyservices.com

OTHER TURBINE COMPONENTS

American Superconductor
(978) 842-3000
www.amsc.com

AMETEK Power Instruments
(585) 263-7700
www.ametekpower.com

Dowding Machining
(517) 663-5156
www.dowdingindustries.com

Eaton Corp.
(419) 891-7635
www.eaton.com

Ebner
(330) 335-1820
www.ebnerfab.com

GEA-Industrial Heat Exchanger Systems, NA
(717) 855-0145
www.gea-ihe.com

Great Lakes Wind Turbines
(231) 941-1150

Leviathan Energy
(323) 281-4070
www.leviathanenergy.com

Marysville Marine Distributors, Inc.
(608) 825-3878
www.marysvillemarine.com

Seamless Rolled Ring Technology



HEAT TREATMENT MACHINING TESTING



Serving Industries:

- Power Generation
- Fabrications
- Gears
- Bearings
- Oil and Gas

Size Capability:

- OD - 7.5" to 120"
- ID - 5.5" to 115"
- Height - 1.5" to 20.75"
- Weight - 15 lbs to 2600 lbs
- Various Carbon and Alloy Steels



800-727-6333 sales@ajaxring.com
www.AjaxRing.com

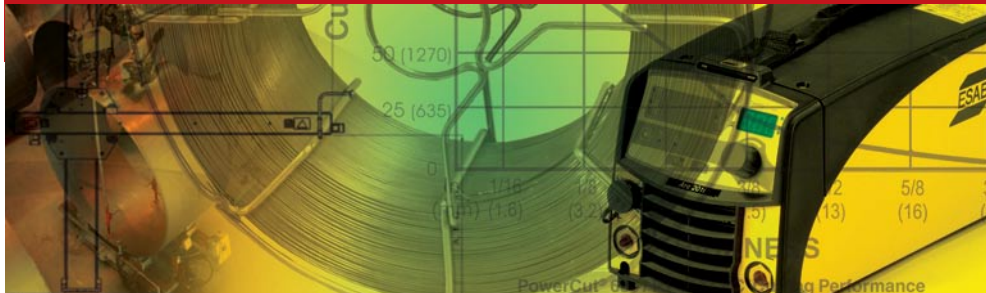

In the early 1900s this company revolutionized the welding process, leading to stronger ships, steel structures, and many years later, wind towers. Their innovations continue.

IN 1904 A SWEDISH ENGINEER by the name of Oscar Kjellberg produced a coated electrode that substantially improved the quality of weld metal. This game-changing development was the foundation of Elektriska Svetsnings-Aktiebolaget, now known as ESAB, one of the world's largest producers of welding consumables and equipment.

"This was just about as revolutionary as you can get," according to Richard Hadley, president of ESAB Group Canada, Inc., and general manager of ESAB Welding Automation North America. "Just think of the difference it made in building ships and other steel structures, which had relied heavily on riveting in the past."

Not only was Kjellberg an extraordinary inventor, he was quite an astute businessman as well, licensing this newly-developed technology to companies around the world—many of which it eventually acquired. Such was the case in the United States, where ESAB's purchase and consolidation of companies such as Alloy Rods and L-Tec to the establishment of its offices there in the late eighties. As a European-based company, however, its entry into the wind-energy market came much earlier.

"During the oil embargo of the mid-seventies, many European countries realized they simply had to decrease their reliance on oil, so that was really the genesis of wind generation there," Hadley says. "The first turbines were supported by metal-lattice structures, but as they grew heavier the industry moved to tubular towers, and that's our specialty. So as the wind industry grew, our tower-building technology grew along with it, and we've also been able to serve as a conduit in carrying that information from Europe to North America."

One longstanding relationship that provides an example of how ESAB collaborates successfully with its customers involves Denmark-based Vestas, the world's leading supplier of windpower solu-

tions. "In the past we've worked closely with Vestas to develop special filler metals to withstand cold temperature service as well as special multiwire high-deposition welding machinery and delivery systems," he says. "More recently we've been heavily involved in the Vestas wind-tower manufacturing facility now being completed in Colorado, which will be the largest in the world. We've been working to meet their requirements nearly since the beginning of this project, and we currently have up to 30 ESAB employees working there to complete the installation and assist with startup."

Perhaps the most astounding piece of equipment developed for this facility is a column and boom that extends the welding head up to 12.5 meters, allowing the head to reach multiple weld seams, and thus increasing efficiency. On a conventional machine the one piece boom extends its full length out the back of the machine during retraction, consuming precious floor space. Working with Vestas, ESAB developed a telescopic boom that retracts into itself without reaching back into the space behind the machine base. "This is a product that didn't exist previously, but they trusted us enough to place the order, and we delivered," Hadley says. "It's probably the largest apparatus of its kind in the world, and I believe it will be a resounding success."

In addition to providing its expertise on cutting-edge projects such as this, ESAB also helps existing facilities to operate more efficiently, suggesting advanced welding processes, handling systems, and many other means of streamlining productivity in an increasingly competitive market. "Everybody wants to be faster and stronger, leaner and meaner, but how you achieve that is different for every company," Hadley says. "We're here to take that into consideration, and to tailor a solution to meet our customer's individual needs." —R. W. 

To learn more call (800) ESAB-123 (372-2123) or go to www.esabna.com.

Metro Mold & Design
(763) 428-8310
www.metromold.com

Nissens AS
45 76262626
www.nissens.com

Power Climber Wind
(800) 560-2546
www.powerclimberwind.com

VETUS America
(410) 712-0740
www.vetus.nl

Willman Industries, Inc.
(920) 668-8526
www.willmanind.com

PITCH/DRIVE SYSTEMS

Baldor Electric Company
(479) 646-4711
www.baldor.com

Balluff, Inc.
(800) 543-8390
www.balluff.com

Bicron Electronics
(860) 824-5125 ext. 1305
www.bicron-magnetics.com

Bonfiglioli U.S.A., Inc.
(859) 334-3333
www.bonfiglioliusa.com

Bosch Rexroth Hydraulics
(610) 694-8300
www.boschrexroth-us.com

Comer Industries
(704) 588-8400
www.comerindustries.com

Dynapar
(800) 873-2666
www.dynapar.com

Heidenhain Corp.
(847) 884-3713
www.heidenhain.com

KEB America, Inc.
(952) 224-1411
www.kebamerica.com

Liebherr-Werk Biberach GmbH
www.liebherr.com

Maxwell Technologies, Inc.
(858) 503-3300
www.maxwell.com

MLS Electrosystems
(412) 424-8900
www.mls-tech.cc

Oil Air Hydraulics, Inc.
(713) 937-8900
www.oilairhydraulics.com

Rotary Systems, Inc.
(800) 959-0146
www.rotarysystems.com

SIPCO
(281) 480-8711
www.sipco-mls.com

SunSource
(630) 317-2714
www.sun-source.com

SLIP RINGS/BRUSHES

AEGIS WTG Shaft Grounding Ring
(207) 998-5140
www.est-aegis.com

Carbone of America
(973) 541-4720
www.carbonebrush.com

Cutsforth, Inc.
(800) 290-6458
www.cutsforth.com

Helwig Carbon Products, Inc.
(414) 354-2411
www.helwigcarbon.com

ICC International
(800) 327-7858
www.iccinternational.com

Lubbock Electric Company, Inc.
(806) 744-2336
www.lubbockelectric.com

Moog Components Group
(540) 552-3011
www.moog.com

Morgan AM&T
(864) 458-7700
www.morganamt.com

Schleifring North America LLC
(847) 429-9801
www.schleifring.com

Smalley Steel Ring
(847) 719-5900
www.smalley.com

United Equipment Accessories
(800) 394-9986
www.uea-inc.com

STEELS/METALS

Aarrowcast, Inc.
(715) 526-3600
www.aarrowcast.com

Ajax Rolled Ring and Machine
(803) 684-3133
www.ajaxring.com

ArcelorMittal, Inc.
(866) 866-6399
www.arcelormittal.com

Bakker Magnetics BV
31 402678678

BJA Magnetics
(508) 886-2166
www.bjamagnetics.com

Buck Company, Inc.
(717) 284-4114
www.buckcompany.com

Citation Corporation
(248) 522-4500
www.citation.net

Concast Metals
(724) 538-3956
www.concast.com

DIS-TRAN Steel Fabrication
(318) 448-0274
www.distran.com

Dura-Bar
(800) 227-6455
www.dura-bar.com

Fehr Bros. Industries, Inc.
(800) 431-3095
www.fehr.com

Helgesen
(262) 709-4401
www.helgesen.com

Industrial Steel Construction
(219) 885-7600
www.iscbridge.com

Leeco Steel LLC
(630) 427-2100
www.leecosteel.com

Mabry Castings, Ltd.
(409) 842-2223
www.mabrycastings.com

McInnes Rolled Rings
(814) 459-4495
www.mcinnesterolledrings.com

Mid America Stainless
(216) 692-3800 ext. 141
www.mastainless.com

Neenah Enterprises, Inc.
(800) 558-5075
www.nfco.com

Olympic Steel Co.
(904) 491-8083
www.olysteel.com

Pegasus Steel
(843) 737-9900
www.pegasussteel.com

Precision Steel Warehouse, Inc.
(847) 455-7000
www.precisionsteel.com

Republic Engineered Products
(800) 232-7157
www.republicengineered.com

Rio Grande Co.
(303) 825-2211
www.riograndeco.com

Standard Iron & Wire Works, Inc.
(763) 295-8711
www.std-iron.com

Steel Works, Inc.
(575) 762-7113
www.steelworksinc.com

Supermetal Structures, Inc.
(418) 834-1955
www.supermetal.com

The Timken Company
(330) 471-5746
www.timken.com

Thermion Metalizing Systems
(360) 692-6469
www.thermioninc.com

Williams Metals and Welding Alloys, Inc.
(610) 225-0105
www.wmwa.net

Willman Industries
(920) 668-8526
www.willmanind.com

Worthington Specialty Processing
(734) 397-5203
www.worthingtonindustries.com

TURBINE SYSTEMS

AAER, Inc.
(450) 534-5155
www.aaer.ca

Abundant Renewable Energy
(503) 538-8298
www.abundantre.com

Acciona Windpower NA LLC
(319) 643-9463
www.acciona-na.com

Aeronautica Windpower LLC
(800) 360-0132
www.aeronauticawind.com

Aerostar, Inc.
(508) 636-5200
www.aerostarwind.com

Alturdyne
(619) 440-5531
www.alturdyne.com

American Electric Technologies, Inc. (AETI)
(412) 478-4792
www.aeti.com.

American Superconductor
(978) 842-3000
www.amsc.com

AMSC Windtec
(978) 842-3000
www.amsc-windtec.com

Beach Wind Consulting Group
(803) 874-4214
www.beachwindconsulting.nexo.com

BroadStar Wind Systems
(330) 923-9734
www.broadstarwindsystems.com

Cleanfield Energy Corp.
(905) 304-5223
www.cleanfieldenergy.com

Clipper Windpower, Inc.
(805) 690-3275
www.clipperwind.com

CSIC-Chongqing HZ Windpower Equipment Co., Ltd.
(519) 560-1413
www.hzfd.com.cn

DeWind, Inc.
(940) 455-7450
www.compositetechcorp.com

Earth Power LLC
(301) 332-1763
www.earthpowerllc.com

Energy Concepts Corporation
(505) 454-0614
www.energyconcepts.net

Endurance Wind Power, Inc.
(888) 440-4451
www.endurancewindpower.com

Enertech
(800) 701-2888
www.enertechwind.com

Entegrity Wind Systems, Inc.
(303) 440-8799
www.entegritywind.com

Farm Boy Energy
(888) 560-4020

Franklin Wind Energy Group
(248) 626-9012
www.franklinwindenergygroup.com

Free Breeze Energy Systems, Ltd.
(519) 885-4311
www.freebreeze.com

Fuhrlaender North America, Inc.
(401) 268-3884
www.fuhrlaenderna.com

Gamesa Wind U.S.
(215) 710-3100
www.gamesacorp.comen

Harness Nature
(515) 987-0518
www.harnessnature.com

Heartland Energy Solutions
(641) 464-3900
www.heartlandenergysolutions.com

Home Energy Americas LLC
(214) 764-6872
www.homeenergyamericas.com

Hyundai Heavy Industries Co., Ltd.
(201) 816-0286
english.hhi.co.kr

Lukhule Moya
(804) 243-9034
www.lukhulemoya.com

Mitsubishi Power Systems
(949) 856-4000
www.mpsHQ.com

Nordex U.S.A., Inc.
(312) 386-4100
www.nordex-online.com

Nordic Windpower U.S.A.
(510) 665-9463
www.nordicwindpower.com

Northeast Alternative Energy
(860) 861-4006
www.nealten.com

Northeast Windpower Corp.
(508) 636-4700
www.northeastwindpower.com

Northern Power Systems
(877) 906-6784
www.northernpower.com

Norwin America LLC
(203) 544-8303
www.norwinamerica.com

Novelution Wind LLC
(857) 453-9943
novelutionwind.com

OEA International, Inc.
(408) 778-6747
www.oea.com

Reflecting Blue Technologies
(847) 624-2865
www.reflectingblue.com

Renewable Energy Technology Group
(425) 831-7915
www.renewableenergytechnologygroup.com

REpower U.S.A. Corp.
(503) 517-7160
www.repower-usa.com

Samsung Heavy Industries
82 556309531
www.shi.samsung.co.kr/eng/

Sauer Energy, Inc.
(888) 820-8748
www.sauerenergy.com

Siemens Energy, Inc.
(407) 736-3381
www.powergeneration.siemens.com

Sinovel Wind Co., Ltd.
86-10-62515566
www.sinovel.com

Solar Wynd
(289) 264-6970
www.solarwynd.ca

Suzlon Wind Energy Corp.
(773) 328-5077
www.suzlon.com

SWG Energy, Inc.
(214) 870-4332
www.swgenery.com

Synergy Wind Power Corp.
(916) 801-5079
www.synergypowercorp.net

Tower Tech Systems, Broadwind Energy
(920) 684-5531
www.towertechsystems.com

Urban Green Energy
(917) 512-9777
www.urbangreenenergy.com

Ventera Energy
(218) 624-4040
www.venturaenergy.com

Vestas
(503) 327-2000
www.vestas.com

Wenvor Technologies, Inc.
(519) 767-5227
www.wenvortechnologies.com

WES Canada
(905) 957-8791
www.windenergysolutions.ca

Wind Power Systems LLC
(954) 422-9564
www.windpowersystemsllc.vpweb.com

Winder Power Systems, Inc.
(603) 569-9774
www.winderpower.com

Windings, Inc.
(507) 233-2034 ext. 116
www.windings.com

Windterra System, Inc.
(866) 771-9463
www.windterra.com

TOWER INTERNALS

AVANTI Wind Systems, Inc.
(262) 641-9101
www.avanti-online.com

CMCBMC Utility Products
(513) 860-4455
www.cmclugs.com

GenMet
(262) 238-7000
www.genmet.com

Millerbernd Laser
(320) 485-2685
www.millerbernd.com

Moltec Windpower Products, Inc.
(503) 352-9847
www.moltecwind.com

ODU U.S.A., Inc.
(805) 484-0540
www.odu-usa.com

Zarges Aluminum Systems
(806) 342-9500
www.zarges.com

TURBINE SUBCOMPONENTS, ELECTRICAL

American Superconductor
(978) 842-3000
www.amsc.com

Bal Seal Engineering, Inc.
(949) 460-2100
www.balseal.comhome

Balluff, Inc.
(800) 543-8390
www.balluff.com

Bicron Electronics
(860) 824-5125 ext. 1305
www.bicron-magnetics.com

Converteam Canada
(450) 857-0877
www.converteam.com

Deublin
(847) 689-8600
www.deublin.com

Acoustic Lubrication

When guesswork is replaced with the "Acoustic Lubrication Method™," rotating equipment failures drop **dramatically**.

Attach the **Ultra-Lube** to your grease gun, and **bearings will tell you when they've had enough grease.**

The Ultra-Lube

- Safe and simple to use
- Extremely durable and rugged
- Reveals existing bearing problems
- Prevents over and under-lubrication
- Eliminates grease gun calibration
- Environmentally conscious
- Great with gearboxes

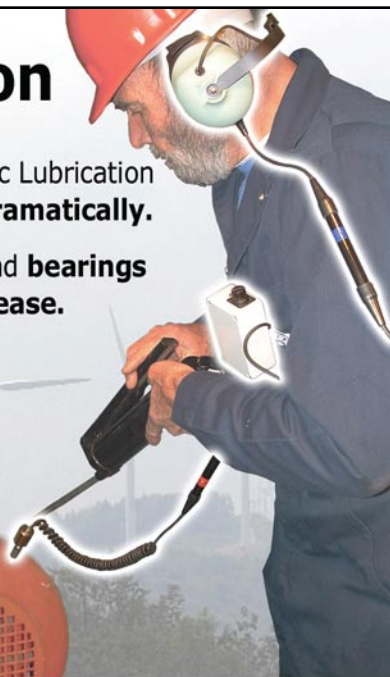

Ph - 360-736-2333 800-736-3757
Fax - 360.736.1579 www.uvlm.com



Uvlm, Inc.

Dynapower Corp.
(800) 292-6792
www.dynapower.com

EPCOS, Inc.
(516) 658-1131
www.epcos.com

FCI-BURNDY Products
(603) 647-5000
www.fciconnect.com

Ferraz Shawmut
(978) 462-6662
www.us.ferrazshawmut.com

Hoffman Enclosures
(763) 422-2380
www.hoffmanonline.com

ILSCO
(513) 533-6200
www.ilsco.com

Lakeland Companies
(612) 240-1547
www.lakelandcompanies.com

Littelfuse
(847) 391-0837
www.littelfuse.com

Marathon Special Products
(419) 352-8441
www.marathonsp.com

Marsh Electronics, Inc.
(800) 236-8327
www.marshelectronics.com

Micronor, Inc.
(805) 499-0114
www.micronor.com

Morgan Rekofa GmbH
(864) 901-3027
www.morgan-rekofa.com

Nichicon Corp.
(847) 843-7500
www.nichicon-us.com

Onyx Power, Inc.
(330) 468-0160
www.onyxpower.com

OZTEK Corporation
(603) 546-0090
www.oztekcorp.com

Sinbon Technologies
(877) 974-6266
www.sinbontech.com

**The Switch Controls
and Converters**
(603) 886-9010
www.theswitch.com

Thomas & Betts
(800) 888-0211
www.tnb.com

TRICO TCWIND, Inc.
(888) 694-6200
www.tricotcwind.com

TURCK, Inc.
(763) 553-7300
www.turck.us

Tyco Electronics Corp.
(800) 522-6752
www.tycoelectronics.com

U.S. Electronics, Inc.
(952) 285-5720
www.usei.com

Van Meter Industrial
(319) 368-2860
www.vanmeterindustrial.com

**Wind Power Online
Marketplace**
(856) 468-5170
www.wind-exchange.com

Woodward SEG
(970) 498-3192
www.woodward.com

MAXIMUM STORAGE

in minimum
space



STOR-LOC MODULAR DRAWER SYSTEM

880 N. Washington Ave. Kankakee, IL 60901
Toll Free: 1.800.786.7562 • Fax: 1.800.315.8769
email: sales@storloc.com
www.storloc.com



Zero-Max
(888) 773-8845
www.zero-max.com

**TURBINE
SUBCOMPONENTS,
MECHANICAL**

AIDA-America Corp.
(937) 235-3556
www.aida-global.com

AmeriStar Manufacturing, Inc.
(507) 625-1515
www.ameristarmfg.com

Balluff, Inc.
(800) 543-8390
www.balluff.com

Diversified Tooling Group
(248) 588-8833
www.diversifiedtoolinggroup.com

**Electro Static
Technology-an ITW Co.**
(866) 738-1857
www.est-aegis.com

Engineering Dynamics
(419) 829-2442

IQ Wind Energy LLC
(305) 592-4404
www.iq-wind.com

K-O Products Company
(800) 633-8078
www.koproducts.com

Kalt Manufacturing Co.
(440) 327-2102
www.kaltmfg.com

KTR Corp.
(219) 872-9100
www.ktrcorp.com

Kurt Manufacturing Company
(763) 572-1500
www.kurt.com

Miller Tool & Die
(517) 782-0347
www.millertd.com

Seeger-OrbisBarnes Group
49 7174205205
www.seeger-orbis.de

Tencarva Machinery Company
(540) 375-7240
www.tencarva.com

The AIM Industrial Group
(586) 776-5500
www.aimindustrial.com

TRICO TCWIND, Inc.
(888) 694-6200
www.tricotcwind.com

WALCO Tool & Engineering
(800) 808-9365
www.walcotool.com

TURBINE TOWERS

Advanced Tower Systems
31 534821400
www.advancedtowers.com

Alpha Workholding Solutions
(877) 217-6900
www.alphaworkholding.com

Ameron Wind Towers
(909) 944-4100
www.ameronwindtowers.com

Cintube
(905) 625-1900
www.cintube.com

DMI Industries, Inc.
(701) 282-6959
www.dmiindustries.com

Dongkuk S&C
82 10 7290 8009
www.dongkuksnc.co.kr

Frisa Forjados
52 8182185571
www.frisa.com

GlenMartin
(800) 486-1223
www.glenmartin.com

Great Lakes Towers LLC
(734) 437-0724
www.greatlaketowers.com

Hitachi Canadian Industries
(306) 242-9222
www.hitachi.sk.ca

KATANA Summit LLC
(402) 563-9318
www.katana-summit.com

Midland Steel Company
(816) 891-8118
www.midlandsteelco.com

Northstar Wind Towers
(402) 426-2104
www.northstarwindtowers.com

ROHN Products LLC
(309) 697-4400
www.rohnnet.com

RTL Windtowers, Inc.
(254) 587-2245

**Shanghai Taisheng
Power Engineering
Machinery Co., Ltd.**
(734) 761-1358
www.aubridge.com

SPECO Wind Power SA de CV
52 8666361010
en.speco.co.kr

**TSP Engineering
Machinery Co.**
(734) 761-1358
www.shtsp.com

Turriss Corp.
(905) 461-9699
www.turriscorp.com

U.S. Tower, Inc.
(508) 636-9100
www.ustower.net

Win & P., Ltd.
82 0220401804
www.winnp.co.kr

WORKHOLDING

**Alpha Workholding
Solutions**
(877) 217-6900
www.alphaworkholding.com

**Big Kaiser
Precision Tooling**
(888) TOOL-PRO
www.bigkaiser.com

Drewco
(262) 886-5050
www.drewco.com

Emuge Corp.
(800) 323-3013
www.emuge.com

**Euro-Tech
Corporation**
(262) 781-6777
www.eurotechcorp.com

Gleason Corp.
(585) 473-1000
www.gleason.com

Hydra-Lock
(586) 783-5007
www.hydralock.com

ITW Workholding
(800) 544-3823
www.itwworkholding.com

Kennametal, Inc.
(800) 446-7738
www.kennametal.com

Kitagawa-NorthTech
(800) 222-4138
www.kitagawa.com

Kurt Workholding
(877) 226-7823
www.kurtworkholding.com

Riten Industries
(800) 338-0027
www.riten.com

SCHUNK Intec
(919) 572-2705
www.schunk-usa.com

Toolink Engineering
(303) 776-6212
www.toolink-eng.com



MISCELLANEOUS

Asset Management/Financial Software	67	Landowner/Project Evaluation	74
Associations.....	67	Legal Resources	74
Avian Assessment	67	Manufacturing/Engineering Software	76
Certification/Testing	67	Public Outreach	76
Consulting Services	67	Safety Training	76
Economic Development.....	69	Shipping Materials	76
Environmental Services	72	Staffing/Recruiting.....	76
Financial Resources	73	Technical Training	78
Insurance Resources.....	74	Wind Resource Analysis Software	78
Land/Permitting Services	74	Windfarm Design/GeoMapping Software.....	78

**ASSET MANAGEMENT/
FINANCIAL SOFTWARE**

Digital Inspections
(800) 877-8783 ext. 1
www.digitalinspections.com

Exaktime
(888) 788-8463
www.exaktime.com

Open Secure Energy Control Systems
(301) 565-4025
www.osecs.com

Quorum Business Solutions
(713) 430-8601
www.qbsol.com

Siterra Corp.
(415) 875-7114
www.siterra.com

Ventyx
(770) 952-8444
www.ventyx.com

ASSOCIATIONS

**American Bearing
Manufacturers Association**
(202) 367-1155
www.abma-dc.org

**American Gear Manufacturers
Association**
(703) 684-0211
wwwAGMA.org/www.gearexpo.com

American Welding Society
(800) 443-9353
www.aws.org

**American Wind Energy
Association**
(202) 383-2500
www.awea.org

ASM International
(440) 338-5151
www.asminternational.org

**Canadian Wind Energy
Association**
(800) 922-6932
www.canwea.ca

**Fabricators & Manufacturers
Association, International**
(815) 399-8775
www.fmanet.org

**National Association
of Tower Erectors**
(605) 882-5865
www.natehome.com

**Society of Manufacturing
Engineers**
(800) 733-4763
www.sme.org

**The Association for
Manufacturing Technology**
(703) 893-2900
www.amtonline.org

World of Concrete
972-536-6379
www.hanleywood.com

AVIAN ASSESSMENT

Bird Barrier America
(310) 527-8000
www.birdbarrier.com

Bird-B-Gone
(949) 472-3122
www.birdbgone.com

Cedarburg Science LLC
(262) 376-0735
www.cedarburgscience.com

Rsell Technologies, Inc.
(604) 985-6047
www.rselltechnologies.ca

Tx-esa
(361) 355-4111
www.tx-esa.com

CERTIFICATION/TESTING

Bureau Veritas
(630) 795-3200
www.bureauveritas.com

Carl Zeiss IMT Corp.
(800) 327-9735
www.zeiss.com

Cinetic Landis
(301) 797-3400
www.fivesgroup.com

**Cloud County Community
College**
(800) 729-5101
www.cloud.edu

DARcorporation
(785) 832-0434
www.darcorp.com

DNV Global Energy Concepts
(206) 387-4200
www.globalenergyconcepts.com

Electric Power Systems
(720) 857-7273
www.eps-international.com

FARO
(407) 333-9911
www.faro.com

Helimax Energy
(514) 272-2175
www.helimax.com

Hexagon Metrology
(401) 886-2000
www.hexagonmetrology.com

**IMCORP-Power
Cable Reliability**
(860) 427-7620
www.imcorpotech.com

MTS Systems Corp.
(800) 328-2255
www.mts.com

**National Institute for
Aviation Research**
(316) 978-5597
www.niar.wichita.edu

SGS Group
(201) 673-7549
www.sgs.com

Spin Trends LLC
(509) 394-2663
www.spintrends.com

Stork Materials Technology
(888) 786-7555
www.storksmt.com

Texas Wind Energy Institute
(806) 742-7202 ext. 313
www.depts.ttu.edu

CONSULTING SERVICES

Airfoils, Inc.
(814) 357-0500
www.airfoils.com

Alliegiance Capital Corp.
(214) 217-7713
www.allcapcorp.com

Alphateam, Inc.
(708) 227-3253
www.alphateaminc.com

Alternegy LLC
(423) 834-2006
www.alternegyllc.com

American Industrial Magic LLC
(231) 883-4463
www.aimagic.org

American Wire Group
(800) 342-7215
www.buyawg.com

BTM Consult ApS
45 97325299
www.btm.dk

**Canadian Association for
Renewable Energies**
(613) 222-6920
www.renewables.ca

**Canadian German Chamber of
Industry and Commerce**
(514) 844-3051
www.ahk.de/en

CrossBridge Solutions
(847) 478-4718
www.crossbridgesolutions.com

DARcorporation
(785) 832-0434
www.darcorp.com

DES Photography
(360) 991-5394
www.desphotography.com

Effective Marketing Associates
(503) 657-5859
www.e-m-a.com

Emerging Energy Research
(617) 551-8480
www.emerging-energy.com

Evans Associates
(262) 242-6000
www.evansassociates.com

Gaelectric LLC
(406) 452-2526
www.gaelectric.ie

Garrad Hassan America, Inc.
(858) 836-3370
www.garradhassan.com

**German-American Chamber of
Commerce of the Midwest**
(312) 644-2662
www.gaccomm.org

Great Lakes WIND Network
(216) 588-1440
www.glwn.org

Green IT Energy Applications
(800) 275-5870
www.greenitea.com

ION Consulting
(303) 503-8836
www.ionconsulting.com

**Karel & Company/Retained
Executive Search**
(203) 341-9911
www.karelco.com

KEMA
(952) 486-7337
www.kema.com

MAKE Consulting
(312) 441-9590
www.make-consulting.com

Martinez Geospatial, Inc.
(952) 698-0230
www.mtzgeo.com

**Milbank, Tweed, Hadley
& McCloy LLP**
(213) 892-4000
www.milbank.com

Native Wind Energy
(513) 899-9152
www.nativewind.org

NOVI Energy LLC
(248) 735-6684
www.novienenergy.com

PBS Engineering
(714) 534-6700
www.pbseng.com

Project Specialists, Inc.
(561) 644-0177

Red Rover
(877) 796-2845
www.red-rover-ltd.com

Quorum Business Solutions
(713) 430-8601
www.qbsol.com

Sargent & Lundy LLC
(312) 269-2000
www.sargentlundy.com

Sentrex Wind Services, Inc.
(506) 849-0026
www.sentrexwind.com

SGE
(617) 875-3987
www.sge-corp.com

Shepherd Advisors
(734) 665-5410
www.shepherdadvisors.com

SINDAL Market Analyst
(951) 325-8005
www.sindal-lundsberg.com

Space Potential
(323) 859-4550
www.spacepotential.com

Sperry Van Ness
(806) 797-2190
www.svn.com

Stork Materials Technology
(888) 786-7555
www.storksmt.com

**Sweetwater Enterprise for
Economic Dev., Inc.**
(325) 235-0555
www.sweetwatertexas.net

Tim Kowalke
(763) 222-4466

TriGlobal Energy LLC
(214) 995-5862
www.triglobalenergy.com

**Trintek Energy
Consulting, Inc.**
(630) 776-6247
www.trintek-energy.com

Utility Wind Integration Group
(703) 860-5160
www.uwig.org

Wesco Wind LLC
(260) 694-6240
www.wescowind.com

Wind Energy TechnoCentre
(418) 368-6162
www.eolien.qc.ca

WindGuard North America, Inc.
(519) 440-0925
www.windguard.ca

ECONOMIC DEVELOPMENT

Abilene Industrial Foundation
(800) 299-0005
www.developabilene.com

APEX
(218) 740-3667
www.apexgetsbusiness.com

Ardmore Development Authority
(580) 223-6162
www.ardmoredevelopment.com

Atchison County Economic Development
(888) 367-5524
www.growatchison.com

Big Sky EDA-EDC
(406) 869-8401
www.bigskyeda.org

Big Spring EDC
(432) 264-6032
www.bigspringtx.com

Buffalo Niagara Partnership
(716) 852-7100
www.thepartnership.com

Caldwell/Canyon EDC
(208) 454-0087
www.caldwellonline.org

Casper Area Economic Development Alliance
(307) 577-7011
www.casperworks.biz

Dumas EDC
(806) 934-3332
www.dumasedc.org

EDC of Shasta County
(530) 224-4920
www.shastaedc.org

Elk Grove EDC
(916) 691-3895
www.elkgroveedc.org

Fillmore County Development Corp.
(402) 759-4910
www.fillmorecountydevelopment.org

Greater Antelope Valley Economic Alliance
(661) 945-2741
www.aveconomy.org

Greater Topeka Chamber of Commerce
(785) 234-2644
www.topekachamber.org

Idaho Department of Commerce
(208) 334-2470
www.commerce.idaho.gov

Junction City Kansas Economic Development
(785) 762-1976
www.jcks.com

Kennebec Valley Council of Governments
(207) 453-4258
www.kvcog.org

Klickitat County EDC
(800) 785-1718
www.klickitatcounty.org

Lee County Economic Development Group
(319) 463-5599
www.lcedg.com

London Economic Development Corporation
(519) 661-4545
www.ledc.com

Marion Economic Development Company
(319) 743-4724
www.medcoiowa.org

Midwest Terminals of Toledo International
(419) 697-2715
www.midwestterminals.com

Minnesota Dept. of Economic Development
(507) 389-6779
www.positivelyminnesota.com

Montana Governor's Office of EDC
(406) 841-2032
www.business.mt.gov

MISCELLANEOUS

PAMPA TEXAS

**WHERE THE WHEAT GROWS,
THE OIL FLOWS, AND
THE WIND BLOWS!**



Clay Rice, Executive Director
pampaedc@sbcbglobal.net

P.O. Box 2398
Pampa, TX 79066-2398
806-665-0800
www.pampaedc.com

Montana West Economic Development
(406) 257-7711
www.dobusinessinmontana.com

Nebraska Public Power District
(402) 563-5538
www.sites.nppd.com

New Mexico ED Partnership
(505) 338-1462
www.nmpartnership.com

New North, Inc.
(920) 336-3860
www.thenewnorth.com

New York State Energy Research & Development
(716) 842-1522
www.nyserda.org

Niagara Economic Development Corporation
(905) 685-1308
www.niagaracanada.com

North Carolina Global Transpark
(252) 522-4929
www.ncgtp.com

Odessa Development Corporation
(877) 363-3772
www.odessatex.com

Ogdensburg Bridge & Port Authority
(315) 393-4080
www.ogdensport.com

Ohio Department of Development
(614) 466-6797
www.development.ohio.gov

Oklahoma Department of Commerce
(405) 815-5251
www.okcommerce.gov

Oregon Business Development Dept.
(503) 986-0071
www.oregon.gov/OBDD

Ontario Canada
(800) 819-8701
www.investinontario.com/green

Pampa EDC
(806) 665-0800
www.pampaedc.com

Portland Development Commission
(503) 823-7994
www.pdc.us

Pottawattamie County Growth Alliance
(866) 466-6484
www.councilbluffsiaowa.com

Rhode Island EDC
(401) 278-9100
www.riedc.com

Sault Ste. Marie EDC
(705) 759-5432
www.sault-canada.com

Welcome to Junction City, Kansas



Where the wind blows...
YOUR COMPANY WILL ROCK!

Jeffrey Black, Executive Director
785.762.1976 • Jeffrey.Black@JCKS.com

JCGC
ECONOMIC DEVELOPMENT

IT'S A WIN WIND SITUATION.



TOPEKA, KANSAS – A BREATH OF FRESH AIR. Located right in the middle of America's wind corridor, Kansas has the third-highest wind energy potential in the nation. We're in just the right place for the transport of energy, and we have the right strategic alliances to grow this innovative industry. Add to that the technical capabilities, readily accessible resources, and a smart and willing workforce for wind turbine and component manufacturing. Learn more about Topeka today by contacting Steve Jenkins at 785.234.2644 or sjenkins@TopekaChamber.org.



TopekaChamber.org

GREATER
TOPEKA.
CHAMBER

 GO TOPEKA

**South Dakota Office of
Economic Development**
(605) 773-3301
www.sdreadytowork.com

**Southern Idaho Economic
Development**
(208) 324-7408
www.southernidaho.org

**Sweetwater Enterprise for
Economic Dev., Inc.**
(325) 235-0555
www.sweetwatertexas.net

**The Amarillo Economic
Development Corp.**
(806) 379-6411
www.amarilloedc.com

West Virginia Development Office
(304) 957-2044
www.wvopenforbusiness.com

Woodward Industrial Foundation
(580) 254-5616
www.wifok.com

ENVIRONMENTAL SERVICES

ABR, Inc.
(503) 359-7525
www.abrinc.com

Activa Environnement
(418) 392-5088
www.activaenviro.ca

Altus Group
(416) 227-7039
www.altusgroup.com

ARCADIS
(978) 937-9999
www.arcadis-us.com

Blondo Consulting LLC
(763) 245-1174
www.blondoconsulting.com

**Cultural Resource
Analysts, Inc.**
(859) 252-4737
www.crai-ky.com

Curry & Kerlinger LLC
(703) 821-1404
www.currykerlinger.com

Ecosystem Management, Inc.
(505) 884-8300
www.emi-nm.com

EDM International
(970) 204-4001
www.edmlink.com

Epsilon Associates, Inc.
(978) 897-7100
www.epsilonassociates.com

ESS Group, Inc.
(401) 434-5560
www.essgroup.com

GAI Consultants, Inc.
(412) 476-2000
www.gaicconsultants.com

Geo-Marine, Inc.
(972) 423-5480
www.geo-marine.com

Easy. Breezy.

SITES.NPPD.COM

A SITE WITH COMPREHENSIVE BUSINESS DEVELOPMENT INFORMATION ON NEBRASKA.



Nebraska Public Power District

1-800-282-6773, ext. 5534



Helimax Energy
(514) 272-2175
www.helimax.com

Integrated Environmental Data
(518) 872-2495
www.iedat.com

JFNew
(574) 586-3400
www.jfnew.com

John Milner Associates, Inc.
(914) 271-0897
www.johnmilnerassociates.com

M.A.A.R.S.
(902) 895-2982
www.mapcmaars.ca

Mostardi Platt Environmental
(630) 993-2114
www.mostardipltattenv.com

Natural Resource Solutions, Inc.
(519) 725-2227
www.nrsi.on.ca

Natural Resources Consulting
(608) 839-1998
www.nrcdifference.com

Nimonik, Inc.
(514) 712-0637
www.nimonik.ca

Northern Environmental
(800) 501-4080
www.northernenvironmental.com

Panamerican Consultants, Inc.
(205) 556-3096
www.panamconsultants.com

PBS&J
(512) 327-6840
www.pbsj.com

PESCA Environnement
(888) 364-3139
www.pescaenvironnement.com

Resource Systems Group
(802) 295-4999
www.rsginc.com

RMT, Inc.
(608) 662-5222
www.rmtinc.com

Sargent & Lundy LLC
(312) 269-2000
www.sargentlundy.com

Shannon & Wilson, Inc.
(509) 946-6309
www.shannonwilson.com

SolWind Power Group
(310) 770-8351
www.solwindpowergroup.com

SWCA Environmental Consultants
(512) 476-0891
www.swca.com

Tech Environmental
(781) 890-2220
www.techenv.com

The Chazen Cos.
(845) 486-1454

Tierra Right of Way Services
(520) 319-2106
www.tierra-row.com

Western Land Services
(307) 673-1817

Westwood Professional Services
(952) 937-5150
www.westwoodps.com

Zotz Ecological Solutions
www.zotzeco.com

FINANCIAL RESOURCES

Advanced Engineering Associates International (AEAI)
(212) 955-9080
www.aeaiinc.com

Advantage For Analysts
(415) 568-4804
www.advantageforanalysts.com

ANV Partners
(303) 296-7777
www.anvpartners.com

Bedford International
(480) 861-2432
www.bedfordcg.com

Boreal Renewable Energy Development
(781) 859-7158
www.boreal-renewable.com

Clean West Capital, Inc.
(604) 998-8319
www.cleanwest.com

Corval Capital, Inc.
(651) 605-2423
www.corvalcapital.com

Environmental Capital LLC
(651) 690-1000
www.environmentalcapital.com

Greenman Financial Advisors LLC
(303) 204-6850
www.greenmanfinancial.com

HFBE Investment Banking
(713) 225-9580
www.hfbe.com

John Deere Wind Energy
(515) 267-4833
www.johndeere.com

Mad River Associates, Inc.
(802) 496-9330
www.madriverassociates.com

Michael Stavy
(312) 832-1631
www.nvo.com

Midwest Wind Finance
(612) 332-0607
www.mwwind.com

Moss Adams LLP
(503) 242-1447
www.mossadams.com

MPowered Structured Solutions
(617) 775-5521
www.mpoweredss.com

Ryan, Inc.
(512) 476-0022
www.ryanco.com

Siemens Financial Services, Inc.
finance.siemens.com

Stirling Mercantile
(604) 484-0072
www.stirlingmercantile.com

Streamline Financial Services
(770) 904-2620
www.streamlinefin.com

WindFarm Finance
(914) 273-2212
www.windfarmfinance.com

INSURANCE RESOURCES

AIG Global Marine and Energy
(212) 458-1414

GCube Insurance Services, Inc.
(760) 880-1646
www.gcube-insurance.com

Holmes Murphy & Associates
(800) 477-2797
www.holmesmurphy.com

Project Risk, Ltd.
(615) 264-6282
www.projrisk.com

Quadrant Insurance Managers
(614) 841-1425
www.quadrant-us.com

Wachovia Insurance Services
(908) 598-6026
www.wachovia.com

Willis HRH
(312) 527-7040
www.willis.com

LAND/PERMITTING SERVICES

AKL Wind Energy Scouting
(432) 213-2049
www.aklwindenergy.com

Altus Group
(416) 227-7039
www.altusgroup.com

CEMCON, Ltd.
(630) 862-2100
www.cemcon.com

Cimmaron Field Services, Inc.
(817) 510-3190
www.cimmaron.com

Cinnabar Service Company
(918) 742-0082
www.cinnabar.cc

Elexco, Ltd.
(519) 686-0470
www.elexco.com

Englobal
(303) 475-0900
www.englobal.com

Faulk & Foster
(800) 779-0495
www.faulkandfoster.com

Frontier Surveying Co.
(361) 881-8044
www.frontiersurveying.com

GAI Consultants, Inc.
(412) 476-2000
www.gaicconsultants.com

Gunter Land Services LLC
(817) 909-8935
www.gunterlandservices.com

Horn Wind LLC
(940) 642-9781
www.hornwind.com

Integrity Land, Inc.
(877) 998-1500
www.integrityland.com

James C. Karo Associates
(303) 279-0789
www.jameskaro.com

Land Matters LLC
(616) 791-9805
www.landmattersllc.com

Linderlake Corp.
(800) 334-2451
www.linderlake.com

NorthSide Management
(208) 331-9680
www.northsidemgt.com

Pilgrim Land Services
(405) 604-8000
www.pilgrimland.com

Terra Consulting Group, Ltd.
(847) 698-6400
www.terraltd.com

Tierra Right of Way Services
(520) 319-2106
www.tierra-row.com

Westwood Professional Services
(952) 937-5150
www.westwoodps.com

Wilson & Co.
(505) 348-4000
www.wilsonco.com

LANDOWNER/PROJECT EVALUATION

ARC Renewables LLC
(843) 851-2505
www.arcrenewables.com

Co-op Wind
(806) 227-2465
www.coopwind.com

New World WindPower LLC
(406) 696-2842
www.newworldwindpower.com

WES Engineering LLC
(608) 259-9304
www.wesengineering.com

Wind Prospect, Inc.
(720) 542-9922
www.windprospect.com

LEGAL RESOURCES

Baker & McKenzie LLP
(312) 861-2811
www.bakernet.com

**Bateman Seidel Miner Blomgren
Chellis & Gram, P.C.**
(503) 972-9920
www.batemanseidel.com

Bond, Schoeneck & King PLLC
(315) 218-8000
www.bsk.com

Cooper Erving & Savage LLP
(518) 449-3900
www.coopererving.com

Dickstein Shapiro LLP
(202) 420-2200
www.dicksteinshapiro.com

Faegre & Benson LLP
(612) 766-7000
www.faegre.com

Fulbright & Jaworski LLP
(612) 321-2800
www.fulbright.com

Gray Plant Mooty
(612) 632-3000
www.gpmlaw.com

Greenberg Traurig LLP
(617) 310-6006
www.gtlaw.com

Hodgson Russ LLP
(716) 856-4000
www.hodgsonruss.com

Hogan & Hartson LLP
(303) 899-7300
www.hhlaw.com

Holland & Knight
(617) 523-2700
www.hklaw.com

Hunton & Williams LLP
(202) 419-2070
www.hunton.com

Mayer Brown LLP
(312) 701-7366
www.mayerbrown.com

McCarter & English LLP
(860) 275-6700
www.mccarter.com

Miller Nash LLP
(503) 224-5858
www.millernash.com

Miller Thomson LLP
(519) 931-3526
www.millertthomson.com

Morgan, Lewis & Bocki LLP
(213) 612-7385
www.morganlewis.com

Osler, Hoskin & Harcourt LLP
(416) 362-2111
www.osler.com

O'Dowd Forensic Weather Services
(403) 277-4313
www.weatherdyne.com

Paul, Hastings, Janofsky & Walker LLP
(312) 499-6000
www.paulhastings.com

Phillips Lytle LLP
(716) 847-8400
www.phillipslytle.com

Richardson & O'Leary PLLC
(208) 938-7901
www.richardsonandoleary.com

Stahl, Bernal & Davies LLP
(512) 346-5558
www.sbaustinlaw.com

Thompson Dorfman Sweatman LLP
(204) 934-2597
www.tdslaw.com

Tonkon Torp LLP
(503) 802-2136
www.tonkon.com

Ungaretti & Harris LLP
(312) 977-4151
www.uhlaw.com

MANUFACTURING/ ENGINEERING SOFTWARE

ETAP
(949) 462-0100
www.etap.com

Manitoba HVDC Research Centre
(204) 989-1240
www.pscad.com

Siterra Corp.
(415) 875-7114
www.siterra.com

TDCI, Inc.
(810) 355-1247
www.tdci.com

PUBLIC OUTREACH

GADORE
49 021146877240
www.gadore.org

Praxis Strategy Group
(701) 499-2111
www.praxisssg.com

South Dakota Wind Energy Association
(605) 295-1221
www.sdwind.com

Tierra Right of Way Services
(520) 319-2106
www.tierra-row.com

SAFETY TRAINING

AVANTI Wind Systems, Inc.
(262) 641-9101
www.avanti-online.com

AVO Training Institute, Inc.
(877) 594-3156
www.avotraining.com

Gravitec Systems, Inc.
(800) 755-8455
www.gravitec.com

MarBec Consulting, Inc.
(706) 364-8050 or 951-6387
www.marbecconsulting.com

PMI
(800) 282-7673
www.pmirope.com

TES, Inc.
(800) 327-4036
www.towergear.com

Texas Wind Energy Institute
(806) 742-7202 ext. 313
www.depts.ttu.edu

SHIPPING MATERIALS

Buffalo Shrink Wrap, Inc.
(716) 759-0462
www.buffaloshrinkwrap.com

Dr. Shrink, Inc.
(231) 723-2685
www.dr-shrink.com

STAFFING/RECRUITING

Advance Technology, Inc.
(757) 310-6967
www.advancetec.info

Burr Beck & Partners
(713) 706-6195
www.burrbeck.com

C.G. & Company
(432) 362-7681
www.cgcompany.com

CapStone Solutions, Inc.
(425) 861-9332
www.capstone-sol.com

Energy Executive Search International
(260) 488-3602
www.energyexecutivesearch.com

Global Recruiters of Boulder
(303) 545-6600 ext. 101
www.grnboulder.com

Golden Triangle Connections
(858) 453-6430
www.gt-connections.com

WIND TURBINE BRAKES.COM

Hydraulic • Pneumatic
Spring Applied • Mechanical

Featuring the H2-90D Hydraulic Brake

Mounting interchangeable
with other brands.
Performance enhanced.

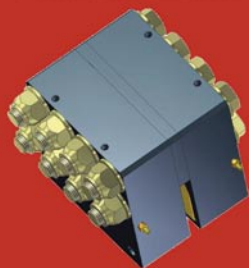

WC BRANHAM
SOLUTIONS IN MOTION

River Falls, WI - Made in U.S.A.
Call Today 1.800.428.1974

Technical Solutions

Aerospace and Automotive Applications

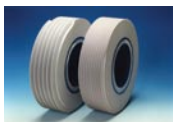

Multiple Start Gear Grinding Wheels

- Lower grinding forces
- New abrasive blends & bonds
- Lower grinding temperatures
- Increased porosity for higher stock removal



Gear Honing Benefits

- Flank correction
- Reduced operating noise
- Longer service life
- Correction for distortion from hardening process



Hermes Abrasives, Ltd.

524 Viking Drive • Virginia Beach, VA 23452
Toll free phone: 800.464.8314
PO Box 2389 • Virginia Beach, VA 23450
Toll free fax: 800.243.7637



PROTECT YOUR BOLTS

YOUR FOUNDATIONS
ARE NOT COMPLETE
WITHOUT PROTECTING
THE ANCHOR BOLTS WITH
IRONCLAD™ BOLT CAPS



**NORM TOOMAN
CONSTRUCTION, INC.**
THE STANDARD OF
THE INDUSTRY.

800.359.0372

NORMTOOMANCONST.COM



Gearbox Repairs & Overhauls

We are well-equipped to support you with any emergency breakdown, schedule repair or preventative maintenance services.

- 24 x 7 availability
- Complete gearbox, cylinder & mechanical overhauls
- Repair journals, housings, shafts, linkages, etc.
- Fabricate replacement parts
- Since 1967



(626) 358-8288
pamcomachine.com

Stahlwille Tools is the ONLY tool company with dimensionally accurate hand tools!

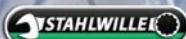

TORQUE WRENCHES

- Super accurate scale designed for industrial applications
- Can be used as a breaker bar with no damage
- Designed to ISO 12 month calibration cycle
- Does not need to be "zero'd" after use
- Interchangeable insert heads



MOBILE TORQUE TESTERS

STAHLWILLE TOOLS NA, SARASOTA FL: 800-695-2714
WWW.STAHLWILLETOOLS.COM

Dealer Inquiries Invited



Professional Tools made in Germany
800-695-2714

"WHEN IT HAS TO BE RIGHT"



Wind Turbine Gearbox Repair Services

- Custom Wind Gear Manufacturing
- Large Gear Grinding to 2.6m
- Gear Metrology Laboratory
- Large Gearbox Assembly to 20 Tons
- Gearbox Testing
- 50 Years of Gearbox Repair Experience
- 24 Hour Factory Operation
- ISO-9001 Registered



THE GEAR WORKS - SEATTLE, INC.
500 S. PORTLAND STREET • SEATTLE, WA 98108-0888
PHONE: 206.762.3333 • FAX: 206.762.3704
EMAIL: SALES@THEGEARWORKS.COM
THEGEARWORKS.COM

Greenman Alliance LLC
(919) 300-1657
www.greenmanalliance.com

Hire To Win
(678) 377-9944
www.hiretowin.com

Innovative Search Solutions
(303) 274-0400
www.innovativesearches.com

Jordan-Sitter Associates
(210) 651-5561
www.jordansitter.com

JS Executive Search
(310) 396-0283
www.searchjs.com

LarsonAllen Search LLC
(612) 376-4849
www.larsonallen.com

Lineal Recruiting Services
(203) 386-1091
www.lineal.com

Ned Turner & Associates, Inc.
(919) 732-2460
www.nedturner.com

Planet Forward
(708) 505-4085
www.theplanetforward.com

Quality Recruiting Solutions
(309) 752-1916
www.wind-energyrecruiting.com

RBG
(281) 279-1000
www.rbgltd.com

RSMR Global Resources, Inc.
(312) 957-0337
www.rsmr.com

SearchPath of Chicago
(815) 261-4403 ext. 100
www.searchpath.com

SOS Staffing Services, Inc.
(801) 484-4400
www.sosstaffing.com

Woodmoor Group
(719) 440-2497
www.woodmoor.com

TECHNICAL TRAINING

Abaris Training Resources, Inc.
(775) 827-6568
www.abaris.com

Airstreams Renewables, Inc.
(861) 822-3963
www.air-streams.com

AVO Training Institute, Inc.
(877) 594-3156
www.avotraining.com

Cerritos College CACT
(310) 984-9734
www.cerritotrainsu.com

Cole Mfg. Systems, Inc.
(248) 601-8145
www.colemfgsystems.com

Fluid Power Training Institute, Inc.
(801) 908-5456
www.fpti.org

General Electric-Wind Energy Training Center
(518) 385-5854
www.ge.com

Illinois Manufacturing Foundation
(773) 277-2343
www.imfjobtraining.org

International Air Academy, Inc.
(360) 695-2500
www.aha.edu

Kalamazoo Valley Community College
(269) 353-1560
www.kvcc.edu

Lakeshore Technical College
(920) 693-1000
www.gotoltc.edu

MN West Community & Technical
(507) 223-7252
www.mnwest.edu

Oklahoma State University
(405) 945-3222
www.osuokc.edu

Ramsay Corporation
(412) 257-0732
www.ramsaycorp.com

Sauk Valley Community College
(815) 288-5511
www.svcc.edu

South Plains College
(806) 894-9611
www3.southplainscollege.edu

Texas State Technical College
(325) 734-3690
www.texaswindenergyinstitute.ttu.edu

Texas Wind Energy Institute
(806) 742-7202 ext. 313
www.depts.ttu.edu

WIND RESOURCE ANALYSIS SOFTWARE

Electrocon International, Inc.
(734) 761-8612
www.electrocon.com

EMD International A/S
45 96354444
www.emd.dk

Meteadyn
33 0240710505
www.meteadyn.com

Mistaya Engineering, Inc.
(403) 971-6912
www.mistaya.ca

WINDFARM DESIGN/GEOMAPPING SOFTWARE

DeLorme
(800) 293-2389
www.delorme.com

ESRI
(909) 793-2853
www.esri.com

Quorum Business Solutions
(713) 430-8601
www.qbsol.com

ADINDEX

Advanced Protection Technologies.....	39
Ajax Rolled Ring & Machine, Inc.....	59
Aztec Bolting.....	31
Bronto Skylift Oy Ab.....	10
Carl Zeiss IMT Corp.....	54
Casper Area Economic Development, Inc.....	79
Curtiss-Wright Flow Control Company.....	IBC
D2000 Safety, Inc.....	19
East Coast Lightning Equipment.....	39
Elk River, Inc.....	21
Energy Storage & Power LLC.....	27
enXco.....	43
ESAB Welding & Cutting Products.....	IFC
Excel Gear, Inc.....	55
Gleason Corporation.....	2
Global Finishing Solutions, Inc.....	24
Greater Topeka Chamber of Commerce.....	71
Havlik International Machinery.....	15
Herguth Laboratories, Inc.....	41
Hermes Abrasives.....	77
HPM America LLC.....	BC
Hydra-Lock Corporation.....	56
Hytorc.....	33
Industrial Piping & Steel Company.....	28
Int'l Specialized Trailer Mfg. LLC.....	35
JLM Systems, Ltd.....	44
JPW Riggers, Inc.....	22
Junction City Kansas EDC.....	70
KB Energy Company.....	22
Lapp USA.....	23
Ludeca, Inc.....	40
McClarín Plastics, Inc.....	48
Mr. Crane.....	13
Nebraska Public Power District.....	72
Norm Tooman Construction, Inc.....	77
Overton Chicago Gear.....	57
Pamco Machine Works, Inc.....	77
Pampa EDC.....	69
Parker Industries.....	51
Polynova Composites.....	50
Polytech Services Company.....	58
R.P. Machine Enterprises, Inc.....	1
Rev1 Wind.....	44
Rohn Products International, L.C.....	14
RSC Equipment Rental.....	4
Sandvik Coromant.....	53
SECO Tools, Inc.....	49
SSB Services, Inc.....	7
Stahlwille Tools NA.....	25,77
Stor-Loc.....	64
Tech Products, Inc.....	19
The Gear Works – Seattle, Inc.....	77
Thermion, Inc.....	28
Threaded Fasteners, Inc.....	21
ThyssenKrupp Safway, Inc.....	17
Trench Grader.....	13
Turner Bros. LLC.....	29
UVLM, Inc.....	63
W. C. Branham, Inc.....	77
Willman Industries.....	79
World of Concrete.....	75

The Source for High Performance Castings



Ductile Iron, Meehanite®, Gray Iron ADI and High Silicon Ductile



- Expanded Capacity for **Nobake Castings 500 to 40,000 lbs**
- Expanded Capacity for Green Sand Molding - 350 to 1500 lbs, Flask Sizes
- Full Service Jobbing Foundry
- Prototypes to Medium Production
- Green Sand Castings up to 500 lbs
- Pattern Shop On Site
- Complete Layout Facilities

Quality You can Count on Today...and Tomorrow



338 South Main St., Cedar Grove, WI 53013

Tel. (920) 668-8526 Fax. (920) 668-8998

E-mail: jhendrickson@willmanind.com Web Site: www.willmanind.com

Casper, Wyoming

- ◆ Many regional wind farm opportunities
- ◆ Skilled workforce
- ◆ Local industrial training programs

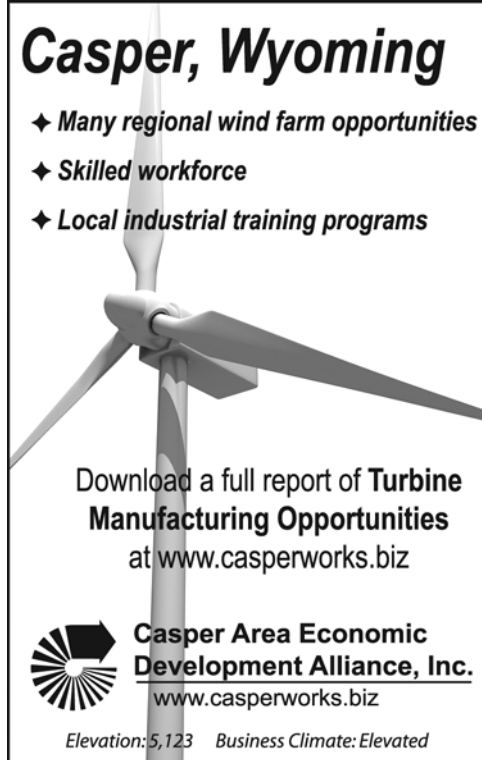

Download a full report of **Turbine Manufacturing Opportunities** at www.casperworks.biz



Casper Area Economic Development Alliance, Inc.
www.casperworks.biz

Elevation: 5,123 Business Climate: Elevated



COULD YOU DESCRIBE THE NPPD'S ORIGINS AND STRUCTURE?

NPPD is a governmental entity, established in 1970 out of a merger among several other public-power organizations, and it is governed by a publicly-elected board of directors representing 11 districts across the state. Our directors serve six-year terms and set direction and policy for NPPD. Primarily a wholesale power supplier, NPPD has about 3,200 megawatts of generation assets consisting of nuclear, coal, hydro, natural gas, oil, and wind resources. NPPD also operates more than 4,000 miles of high-voltage transmission lines, covering a large share of the state. Our wholesale customers account for approximately three fourths of our total revenues, with the remainder of our revenues coming from energy sold directly to retail customers. Our charter service territory is 91 out of 93 counties, so our retail customers are located throughout the state, in communities outside of Lincoln and Omaha.

WHEN DID YOU DECIDE TO PURSUE WIND AS A POWER SOURCE?

The board of directors approved our first wind project in 1998 in order to learn more about wind generation and how to integrate it into our system on a small scale. It consisted of two 750-kilowatt turbines located in north-central Nebraska. Our next project, in 2005, was the Ainsworth Wind Energy Facility, which we own and operate. It generates approximately 60MW of electricity with 36 turbines. NPPD retains about 32 megawatts and sells the remaining 28 megawatts to other public-power entities around the state and country. While the large wind farm

performed well the first year, we have learned many lessons while operating this facility, and there were some problems to overcome in subsequent years. Nebraska's environment brings rain, snow, sleet, ice, and dramatically changing wind conditions, not to mention temperatures as high as 110 degrees down to 25 below, so we had some problems with blades cracking, gear-boxes, and other maintenance issues. NPPD has since decided to take a different approach to incorporating wind into our generation assets.

WHAT DOES THIS NEW APPROACH INVOLVE?

Rather than continuing to develop wind farms as the owner/operator, we've begun working with private developers who construct, own, and operate them in areas we have approved. The sites we've identified meet two primary criteria; that they have a steady wind supply and are located near existing high-voltage power lines. In this arrangement, NPPD doesn't have to provide financing to construct the farms, and we don't have operational responsibilities. In addition, the private developers are able to take advantage of federal incentives that NPPD isn't eligible for. We purchase the output from them at a fixed rate, so we know exactly what we will be paying for the duration of the contract. Our process begins with issuing a request for proposal, or RFP. In 2008, NPPD signed a power purchase agreement for 80MW from the first of these projects, the Elkhorn Ridge Wind Facility, which came online earlier this year. We see this as a great relationship because we didn't have to raise capital, and the owner/operator is responsible for all maintenance and upkeep.

WHAT IS YOUR PROGNOSIS FOR THE FUTURE OF WIND ENERGY IN YOUR POWER PORTFOLIO?

Wind will provide an increasingly larger share of NPPD's energy in the future. Even though less than 2 percent of our energy requirements are currently derived from wind, our board of directors recently established a goal of 10 percent by the year 2020, which I am confident we'll be able to meet. Nebraska reportedly has the sixth-best wind potential in America, so there is opportunity here, especially for wind industry equipment manufacturers. The state is central to areas where wind generation has the most potential. Nebraska has an excellent workforce, some of the lowest electricity rates in the country, and state incentives for both developers and manufacturers who are thinking of locating here. I can assure you that there is a great deal of opportunity for wind industry manufacturers here in Nebraska. ↴

Call (877) ASK-NPPD (275-6773) or go to www.nppd.com.

"It's like having a Tech in the Turbine"

Pete Levitt, VP
CalWind Resources, Inc.

"If an operator wants to know how things are going inside the nacelle of a wind turbine, there are two choices; send a technician up everyday, or sensor it with Swantech. It's like having a technician in the turbine everyday".



goes beyond traditional condition monitoring by...

- Determining lubricant condition
- Recognizing and avoiding secondary damage
- Understanding the impact of operational decisions
- Identifying how stress from loading contributes to part fatigue

Maintain the right turbine at the right time. You'll know the condition of your wind turbines major components 24/7. Stay ahead of the maintenance curve by detecting the onset of lubricant breakdown and component failure at the earliest stages.

Your tech in the turbine, SWANwind, detects faults, isolates the part and defines the failure.

Capture the advantage. Let Swantech put a tech in your turbine.

Call 954.332.6710 x227
www.swantech.com

**CURTISS
WRIGHT**
Flow Control Company
SWANtech

Please contact us to find out more information on becoming a dealer.



From **1 kW to 1 MW** HPM America has a size to fit your requirements

> 1 to 1 - Your Total Community Wind Provider

From 1kW to 1MW HPM America has a size to fit your requirements with a proven technology that delivers the next generation of wind power needed for diverse energy applications.

Our new turbine designs are exceptionally versatile and can be configured to fit a wide array of applications. With our industry best power to weight ratio, turbine design is now simpler.

**LOOKING
FOR DEALERS**



sales@hpmamerica.com | www.hpmamerica.com

820 WEST MARION ROAD, MOUNT GILEAD, OHIO 43338

> 419.946.0222 

> 419.946.2473 